

JVC

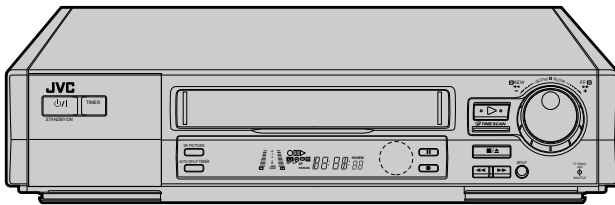

VIDEO CASSETTE RECORDER

HR-DD949EE



 **TIME SCAN**

SHOWVIEW *Hi-Fi* **VHS**
PAL

INSTRUCTIONS

ENGLISH

CONTENTS

SAFETY FIRST	2
Safety Precautions	2
INSTALLING YOUR NEW RECORDER 3	
Basic Connections	3
INITIAL SETTINGS	4
Auto Set Up	4
Language Set	5
Video Channel Set	6
Clock Set	8
On-Screen Displays	9
PLAYBACK	10
Basic Playback	10
Playback Features	11
TimeScan	16
RECORDING	18
Basic Recording	18
Recording Features	19
B.E.S.T. Picture System	20
TIMER RECORDING	22
SHOWVIEW Setup	22
SHOWVIEW Timer Recording.....	24
Regular Timer Programming	26
SPECIAL FEATURES	30
TV Multi-Brand Remote Control	30
Satellite Tuner Multi-Brand Remote Control	31
EDITING	32
Edit To Or From Another Video Recorder	32
Edit From A Camcorder	34
Audio Dubbing	35
Insert Editing	36
INFORMATION ON J TERMINAL	38
TUNER SET	39
TROUBLESHOOTING	44
QUESTIONS AND ANSWERS	47
INDEX	48
SPECIFICATIONS	51

Safety Precautions

The rating plate and the safety caution are on the rear of the unit.

WARNING: DANGEROUS VOLTAGE INSIDE

WARNING: TO PREVENT FIRE OR SHOCK HAZARD, DO NOT EXPOSE THIS UNIT TO RAIN OR MOISTURE.

CAUTION

- When you are not using the recorder for a long period of time, it is recommended that you disconnect the power cord from the mains outlet.
- Dangerous voltage inside. Refer internal servicing to qualified service personnel. To prevent electric shock or fire hazard, remove the power cord from the mains outlet prior to connecting or disconnecting any signal lead or aerial.

ATTENTION

1. This recorder can also receive SECAM colour television signals for recording and playback.
2. Recordings made of SECAM television signals produce monochrome pictures if played back on another video recorder of SECAM standard, or do not produce normal colour pictures if played back on another video recorder of PAL standard.
3. SECAM prerecorded cassettes or recordings made with a SECAM video recorder produce monochrome pictures when played back with this recorder.

POWER SYSTEM

This set operates on voltage of AC110 – 240 V \sim (Rating), AC90 – 260 V \sim (Operating), 50/60 Hz with automatic switching.

IMPORTANT

- Please read the various precautions on this page before installing or operating the recorder.
- It should be noted that it may be unlawful to re-record pre-recorded tapes, records, or discs without the consent of the owner of copyright in the sound or video recording, broadcast or cable programme and in any literary, dramatic, musical, or artistic work embodied therein.

The STANDBY/ON ϕ /I button does not completely shut off mains power from the unit, but switches operating current on and off. " ϕ " shows electrical power standby and " I " shows ON.

Video tapes recorded with this video recorder in the LP (Long Play) mode cannot be played back on a single-speed video recorder.

Failure to heed the following precautions may result in damage to the recorder, remote control or video cassette.

1. **DO NOT place the recorder . . .**
 - ... in an environment prone to extreme temperatures or humidity.
 - ... in direct sunlight.
 - ... in a dusty environment.
 - ... in an environment where strong magnetic fields are generated.
 - ... on a surface that is unstable or subject to vibration.
2. **DO NOT block the recorder's ventilation openings.**
3. **DO NOT place heavy objects on the recorder or remote control.**
4. **DO NOT place anything which might spill on top of the recorder or remote control.**
5. **AVOID violent shocks to the recorder during transport.**

MOISTURE CONDENSATION

Moisture in the air will condense on the recorder when you move it from a cold place to a warm place, or under extremely humid conditions—just as water droplets form in the surface of a glass filled with cold liquid. Moisture condensation on the head drum will cause damage to the tape. In conditions where condensation may occur, keep the recorder turned on for a few hours to let the moisture dry.

ABOUT HEAD CLEANING

Accumulation of dirt and other particles on the video heads may cause the playback picture to become blurred or interrupted. Be sure to contact your nearest JVC dealer if such troubles occur.



- Only cassettes marked "VHS" can be used with this videorecorder.
- HQ VHS is compatible with existing VHS equipment.
- Certain audio features of this product manufactured under a license from Desper Products, Inc. Spatializer® is a trademark owned by Desper Products, Inc.
- SHOWVIEW is a registered trademark of Gemstar Development Corporation. The SHOWVIEW system is manufactured under licence from Gemstar Development Corporation.

Basic Connections

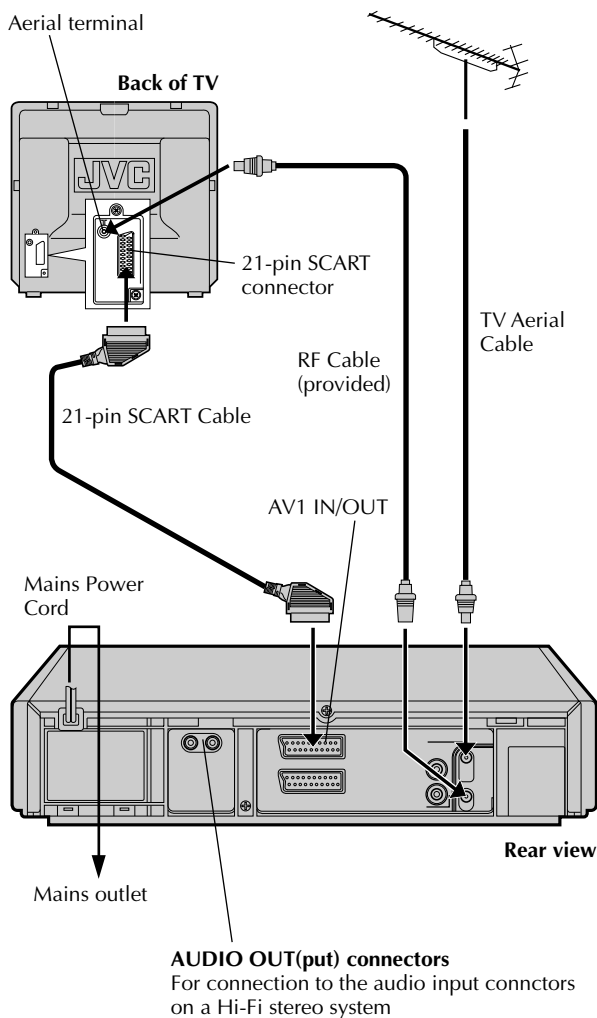

It's essential that your video recorder be properly connected. Follow these steps carefully. **THESE STEPS MUST BE COMPLETED BEFORE ANY VIDEO OPERATION CAN BE PERFORMED.**

- 1 CHECK CONTENTS**
Make sure the package contains all of the accessories listed in "Specifications" (☞ pg. 51).
- 2 SITUATE RECORDER**
Place the recorder on a stable, horizontal surface.
- 3 CONNECT RECORDER TO TV**
The connection method you use depends on the type of TV you have.
RF CONNECTION
 - *To Connect To A TV With NO AV Input Terminals . . .*
 - a- Disconnect the TV aerial cable from the TV.
 - b- Connect the TV aerial cable to the ANT. IN jack on the rear panel of the recorder.
 - c- Connect the provided RF cable between the RF OUT jack on the rear panel of the recorder and the TV's aerial terminal.**Before operating the recorder, make sure the TV's channel is set to the VIDEO channel (☞ pg. 6).**
AV CONNECTION
 - *To Connect To A TV With AV Input Terminals . . .*
 - a- Connect the aerial, recorder and TV as per "RF CONNECTION".
 - b- Connect an optional SCART cable between the AV1 IN/OUT connector on the rear panel of the recorder and the TV's 21-pin SCART connector.**Before operating the recorder, make sure the TV is set to the VIDEO (or AV) mode.**
- 4 CONNECT RECORDER TO MAINS**
Plug the end of the mains power cord into a mains outlet.

After you plug the mains power cord into a mains outlet, the Auto Set Up display appears on the TV screen and/or on the recorder's front display panel when the button on the recorder/remote control is pressed for the first time to power on the recorder ☞ pg. 4.

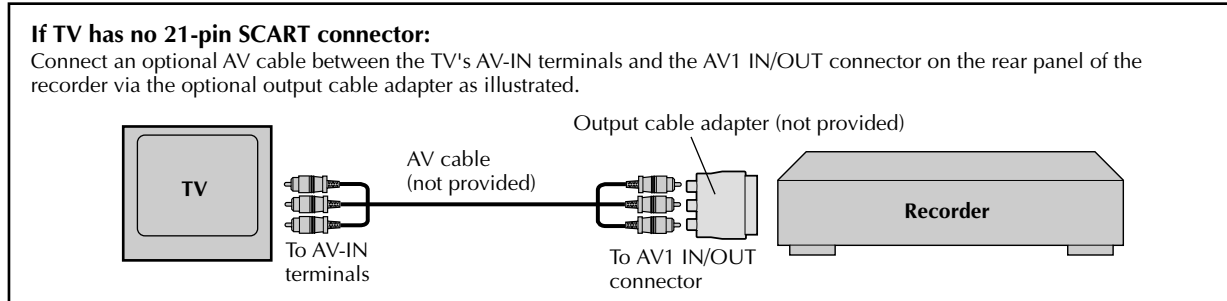

Auto Set Up

Auto Channel Set

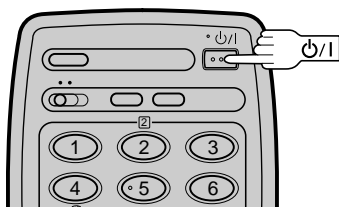
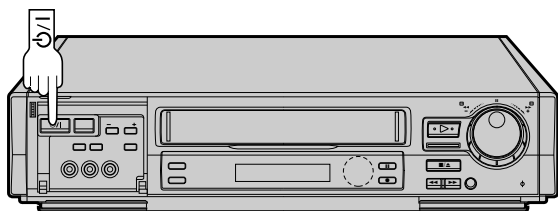

ATTENTION

Once you have performed Auto Set Up, even if the recorder's memory backup has expired, all the stored stations remain in the recorder's memory and the recorder will not perform Auto Set Up again. If you have moved to a different area or a new station starts broadcasting in your area, perform tuner setting. [↗ pg. 39](#)

When the **⏻/I** button on the recorder/remote control is pressed for the first time to power on the recorder after you plug the mains power cord into a mains outlet, the Auto Set Up function sets the tuner channels automatically. You can refer to the front display panel and/or the on-screen display to perform this procedure.

Before starting, make sure of the following:

- The TV aerial cable should be connected to the recorder.
- The recorder's mains power cord should be connected to a mains outlet. [↗ pg. 3](#)
- If you want to use the on-screen display, the TV should be set to its AV mode (with AV connection [↗ pg. 3](#)) or UHF channel 36 (with RF connection [↗ pg. 3](#)).

START AUTO SET UP

1 Press **⏻/I**.

- The Auto Set Up function scans all the channels that are receivable by your recorder. It then automatically assigns each receivable channels to the **TV PROG** buttons. It skips non-receivable channels.
- As Auto Set Up progresses, the "■" mark on the screen moves from left to right.
- After you perform Auto Set Up, if the tuner channels have not been set properly or if "CH --" is displayed on the front display panel, make sure that the aerial cable is connected to the recorder properly and turn off the recorder power once, and turn the power back on to try Auto Set Up again.
- If there is a power cut, or if you press **⏻/I** or **MENU** while Auto Set Up is in progress, Auto Set Up will be interrupted; be sure to turn off the recorder power once and try again.

DO NOT press any button on the recorder or remote control while Auto Set Up is in progress.

On-Screen Display

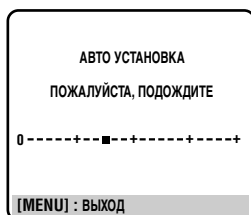

During Auto Set Up "ПОЖАЛУЙСТА, ПОДОЖДИТЕ", blinks on the screen and "Auto" blinks on the front display panel.

Front Display Panel

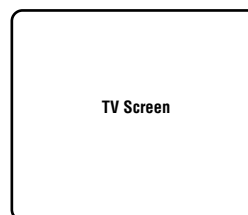

When Auto Set Up is completed, the lowest position number will appear on the front display panel.



NOTES:

- If you have connected your TV to the recorder with RF connection and the on-screen display appearing on UHF channel 36 looks distorted, refer to the front display panel.
- If you want to set the tuner manually such as to add or skip channels, to swap channel positions, to fine-tune channels or to set station names (ID – [↗ p. 43](#)), [↗ pg. 40 – 43](#).
- If no sound accompanies the picture on some channels that have been stored by Auto Set Up, the TV system setting for those channels may be incorrect. Select the appropriate TV system for those channels. [↗ "TV System Selection – When you see the picture but hear no audio" on page 41.](#)

Language Set

- Be sure to set your Video Channel before performing Language setting (see pg. 6).
- Turn on the TV and select the VIDEO channel (or AV mode).

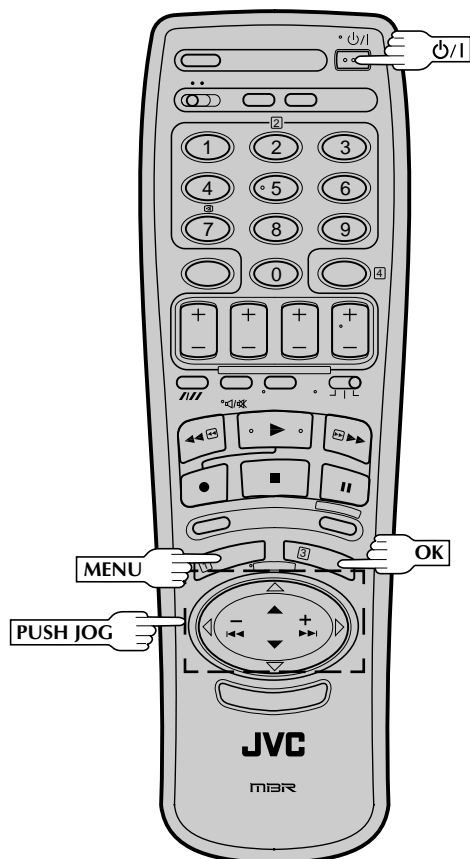

This recorder offers you the choice to view on-screen messages in English or Russian. Select the desired language using this procedure. The default setting is Russian.

TURN ON THE RECORDER

Press **Power**.

ACCESS MAIN MENU

Press **MENU** twice.

ACCESS LANGUAGE SET SCREEN

Press **PUSH JOG** to move the highlight bar (pointer) to "ВЫБОР ЯЗЫКА (LANGUAGE SELECT)", then press **OK**.

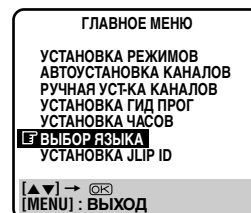

SELECT LANGUAGE

Press **PUSH JOG** to move the highlight bar (pointer) to the language of your choice.

RETURN TO NORMAL SCREEN

Press **MENU**.

Video Channel Set

Video Channel (RF Output Channel) is the channel on which your TV receives picture and sound signals from the video recorder through the RF cable.

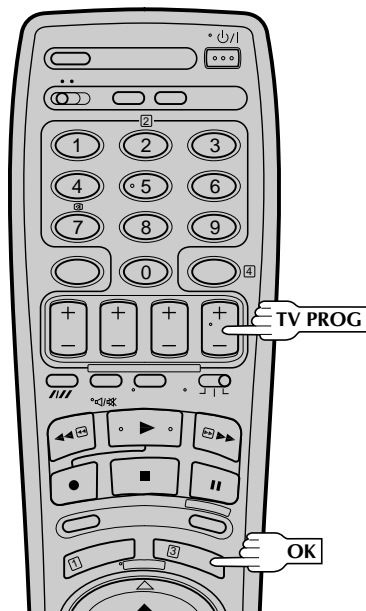
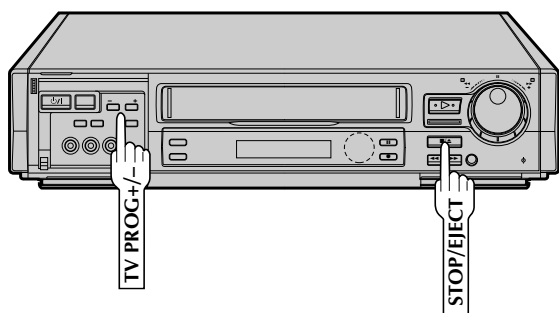

TEST SIGNAL

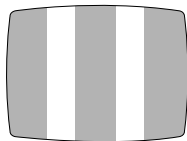

The channel on which the screen to the left appears clearly in step 2 is your Video Channel.

To view picture signals from the video recorder, set your TV to the Video Channel.

If you have connected the video recorder to your TV via the provided RF cable only (RF connection) – Go to "With RF Connection" below.

If you have connected the video recorder to your TV via both the provided RF cable and a 21-pin SCART cable or AV cable (AV connection) – Go to "With AV Connection" on next page.

With RF Connection

IMPORTANT:

Before performing the following steps, make sure the recorder's power is off and there is no cassette inserted in the recorder.

ACCESS VIDEO CHANNEL SET MODE

Hold down **STOP/EJECT** on the recorder until the display panel shows the following.



SET VIDEO CHANNEL

Set your TV to UHF channel 36.

- If the two vertical white bars appear clearly on the screen as shown in the illustration at bottom left, press **OK** and then go to step 3.
- If the two vertical white bars do not appear clearly, press **TV PROG** + or – to set the video recorder to a vacant channel between 22 and 69 which is not occupied by any local station in your area.

(Ex.) If channel 50 is available in your area



Then set your TV to UHF channel 50 and check if the two vertical white bars appear clearly on the screen; if so, press **OK** and then go to step 3. If not, re-set the video recorder to another vacant channel and try again.

NOTES:

- If you set the video recorder to a channel which is occupied by a local station or has neighbouring channels that are occupied by local stations, the picture reception quality will be affected and some interference noise will appear on the TV screen. Be sure to select a vacant channel which has no broadcast on neighbouring channels.
- If you cannot obtain the two vertical white bars clearly with any channel between 22 and 69, consult your JVC dealer.

SELECT TV SYSTEM

3 Press **TV PROG +** or **-** to set appropriate TV system that matches the system of TV being used (refer to the table below).



1 : B/G 2 : D/K

Major Countries	TV System
Austria, Denmark, Finland, Holland, Italy, Norway, Spain, Switzerland, Sweden, Germany, Egypt	B/G
China, Mongolia, Rumania, Bulgaria, Czech Rep., Slovakia, Hungary, Poland, Russia	D/K

EXIT VIDEO CHANNEL SET MODE

4 Press **OK** to finish the setting.

With AV Connection

IMPORTANT:

Before performing the following steps, make sure the recorder's power is off and there is no cassette inserted in the recorder.

ACCESS VIDEO CHANNEL SET MODE

1 Hold down **STOP/EJECT** on the recorder until the display panel shows the following.



SET VIDEO CHANNEL

Press **TV PROG -** until the display panel shows "-_OUT--".



- Now the video channel is set to off.

EXIT VIDEO CHANNEL SET MODE

3 Press **OK** twice to finish the setting.

To view picture signals from the video recorder, set your TV to its AV mode.

Clock Set

Turn on the TV and select the VIDEO channel (or AV mode).

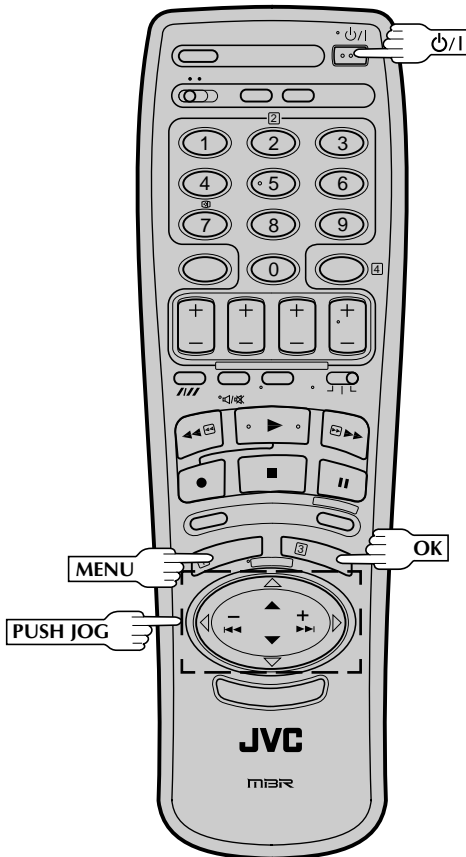

1 TURN THE RECORDER ON

Press $\phi/1$.

2 ACCESS MAIN MENU SCREEN

Press MENU twice.

3 ACCESS CLOCK SET SCREEN

Move the highlight bar (pointer) to "CLOCK SET" by pressing **PUSH JOG** $\Delta \nabla$, then press **OK**. The Clock Set screen appears.

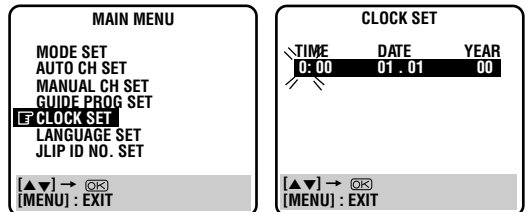

4 SET DATE AND TIME

Press **PUSH JOG** $\Delta \nabla$ to set the hour, then press **OK**. The "minutes" display begins blinking. Repeat the procedure to set the minutes, day, month and year.

5 START CLOCK OPERATION

Press MENU.

NOTES:

- If the day and month data are invalid (such as 31st April), the month digits are cleared automatically and the day digits begin blinking. Input the correct data.
- If, in step 4 the year digits are automatically cleared and the day digits begin blinking, it is possible that you have input 29th February for a non-leap year. Input the correct data.

On-Screen Displays

Turn on the TV and select the VIDEO channel (or AV mode).

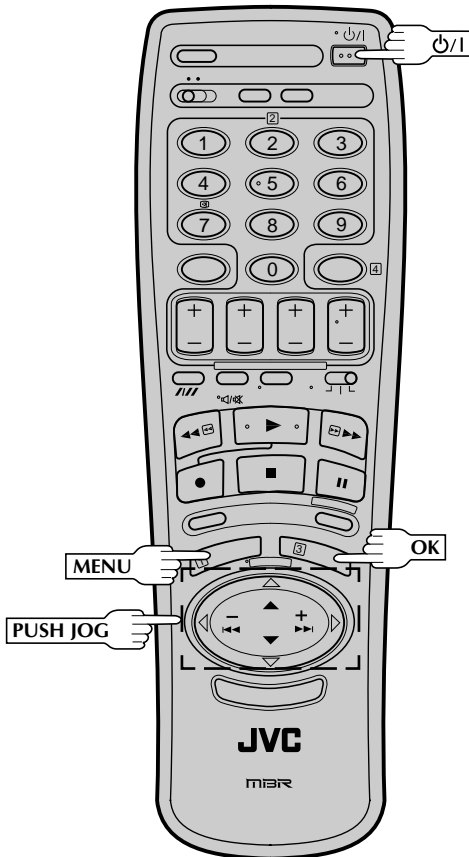

You can choose whether or not to have various operational indicators appear on screen, by setting this function ON or OFF. Messages appear in the selected language (☞ pg. 5).

1 TURN ON THE RECORDER

Press **1**.

2 ACCESS MAIN MENU SCREEN

Press **MENU** twice.

3 ACCESS MODE SET SCREEN

Move the highlight bar (pointer) to "MODE SET" by pressing **PUSH JOG** $\Delta \nabla$, then press **OK**.

4 ENABLE/DISABLE ON-SCREEN DISPLAY

The default setting is "ON", so if you want on-screen displays, leave the setting as it is and go to step 5. If you don't want the displays to appear, press **PUSH JOG** $\Delta \nabla$ to move the highlight bar (pointer) to "O.S.D." and press **PUSH JOG** \triangleright to set "O.S.D." to "OFF".

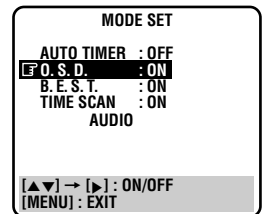

5 RETURN TO NORMAL

Press **MENU**.

NOTES:

- When you use this recorder as the player for editing, be sure to set "O.S.D." to "OFF" before starting.
- During playback, the operation mode indicators may be disturbed depending on the type of tape being used.

The superimposed indication on the TV screen tells you what the recorder is doing.

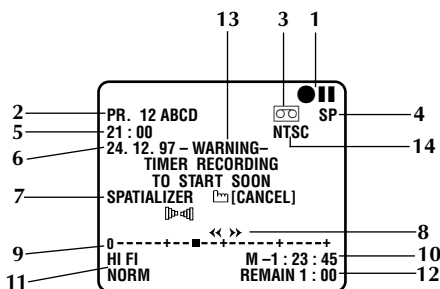

- 1- Operation mode indicators
- 2- Channel position number and station name*/Aux. indicator (AUX1, AUX2 or F-AUX)
* Displayed only if you have set manually (☞ pg. 42)
- 3- Cassette loaded mark
- 4- Tape speed SP/LP/EP (EP is for NTSC playback only)
- 5- Clock display
- 6- Current day/month/year
- 7- Spatializer® indicator (☞ pg. 14)
- 8- Tape direction
- 9- Tape position indicator (☞ pg. 12)
- 10- Counter display (including Counter Memory indicator)
- 11- Audio mode display (☞ pg. 14)
- 12- Tape remaining time indicator (☞ pg. 19)
- 13- Timer warning display (☞ pg. 29)
- 14- NTSC/MESECAM display (☞ pg. 12, 13)

Basic Playback

Turn on the TV and select the VIDEO channel (or AV mode).

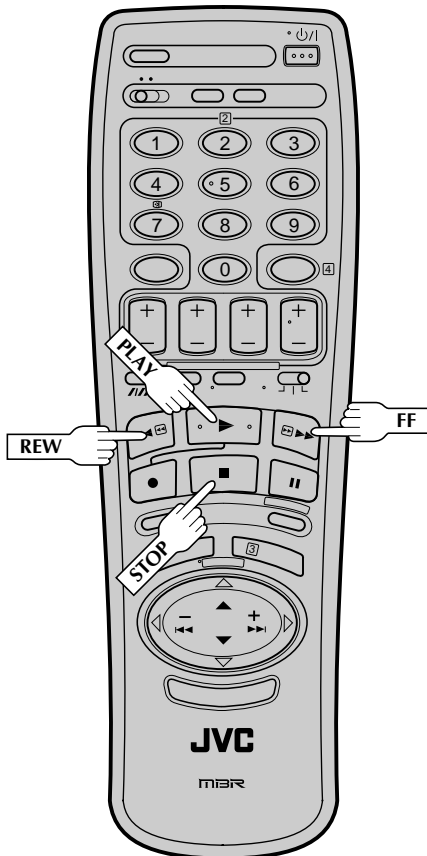
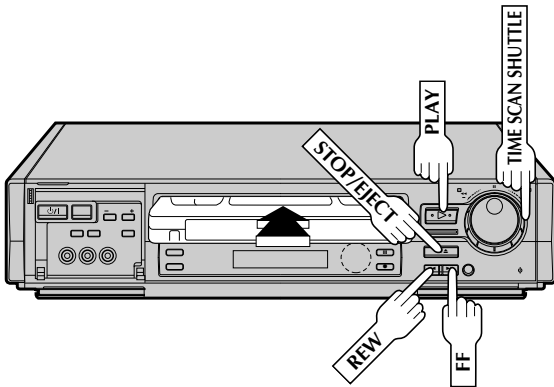

The easiest, most basic operation possible with your video recorder is tape playback. Already-recorded signals on a video tape are read by your video recorder and displayed on your TV just like a TV programme.

1

LOAD A CASSETTE

Make sure the window side is up, the rear label side is facing you and the arrow on the front of the cassette is point toward the recorder. Don't apply too much pressure when inserting.

- The recorder power comes on automatically and the counter is reset to 0:00:00.
- If the record safety tab has been removed, playback begins automatically.

2

FIND PROGRAMME START POINT

If the tape is advanced past the start point, press **REW** or turn the **TIME SCAN SHUTTLE** ring to the left. To go forward, press **FF** or turn the **TIME SCAN SHUTTLE** ring to the right.

3

START PLAYBACK

Press **PLAY**. "BEST" appears blinking in the recorder's display panel during automatic tracking. (☞ pg. 20)

4

STOP PLAYBACK

Press **STOP** on the remote or **STOP/EJECT** on the recorder's front panel. Then press **STOP/EJECT** to remove the cassette.

Usable cassettes

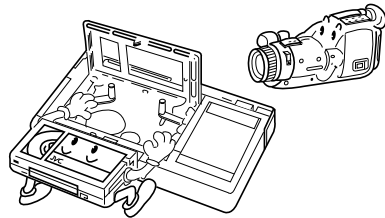

- Compact VHS camcorder recordings can be played on this video recorder. Simply place the recorded cassette into a VHS Cassette Adapter and it can be used just like any full-sized VHS cassette.
- This video recorder can record on regular VHS and Super VHS cassettes. However, it will record and play back regular VHS signals only. It is not possible to play back a recorded Super VHS tape.

Playback Features

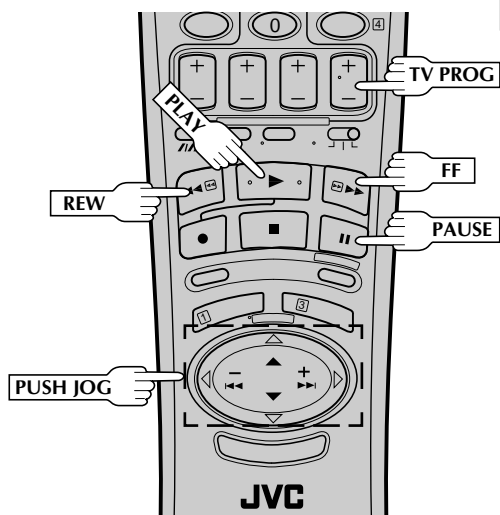
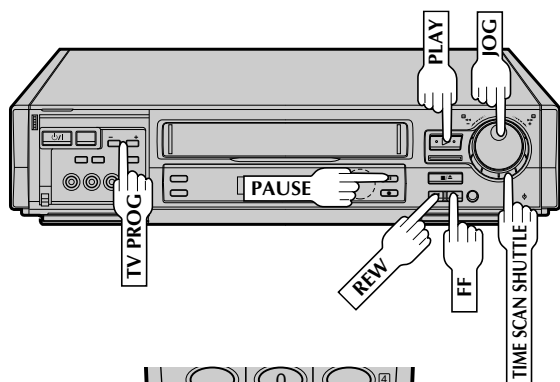

Take advantage of special functions possible with the recorder's controls or the remote control.

Still Picture/Frame-By-Frame Playback

1 PAUSE DURING PLAYBACK

Press **PAUSE**. If there is vertical jitter, use the **TV PROG** buttons to correct the picture.

- During still picture, the sound from the previous 3 seconds (approx.) will be played back repeatedly (provided there was at least 6 seconds of normal playback prior to engaging the still picture mode). However, the **TIME SCAN** indicator will not light.
- "TIME SCAN AUDIO" must be set to "ON", or the sound will not be heard. (☞ pg. 17)

2 ACTIVATE FRAME-BY-FRAME PLAYBACK

Turn the **JOG** dial to the right for forward frame-by-frame playback, or to the left for reverse frame-by-frame playback.

OR

Press **PAUSE**.

OR

Press **PUSH JOG** ◀ or ▶.

To resume normal playback, press **PLAY**.

Slow Motion

1 ACTIVATE SLOW-MOTION PLAYBACK

Turn the **TIME SCAN SHUTTLE** ring to the left or press **PUSH JOG** ◀ during playback to decrease speed in the forward direction. To play in reverse slow-motion (and in reverse play mode), continue to turn the **TIME SCAN SHUTTLE** ring to the left or press **PUSH JOG** ◀ after selecting all the forward direction slow-motion modes.

OR

During still picture, turn the **TIME SCAN SHUTTLE** ring to the right for forward slow motion, or to the left for reverse slow motion.

OR

During still picture, press and hold **PAUSE** for 2 seconds, then release. Press and release again to return to still picture.

OR

During still picture, press and hold **PUSH JOG** ◀ or ▶. Release to return to still picture.

To resume normal playback, press **PLAY**.

High-Speed Search

1 ACTIVATE HIGH-SPEED SEARCH

During playback or still picture, press **FF** for forward high-speed search, or **REW** for reverse high-speed search.

To resume normal playback, press **PLAY**.

NOTES:

- For short searches during playback or still, press and hold **FF** or **REW** for over 2 seconds. When released, normal playback resumes.
- Picture may not appear during search with an LP-recorded tape.
- In the search, still, or frame by frame playback mode, the picture will be distorted, and there may be a loss of colour.

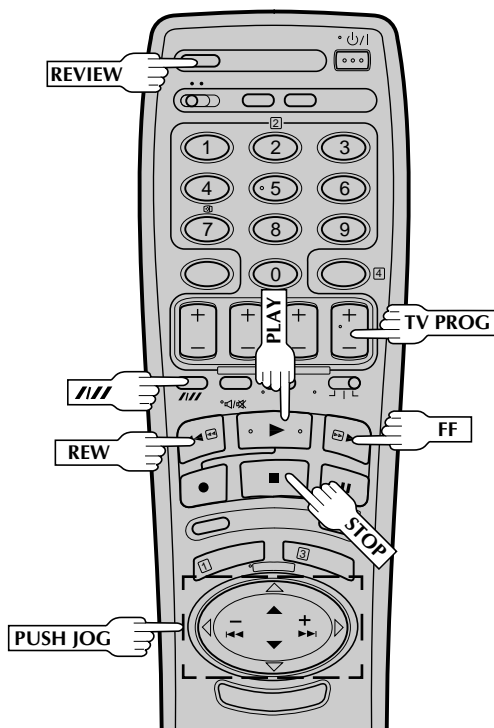
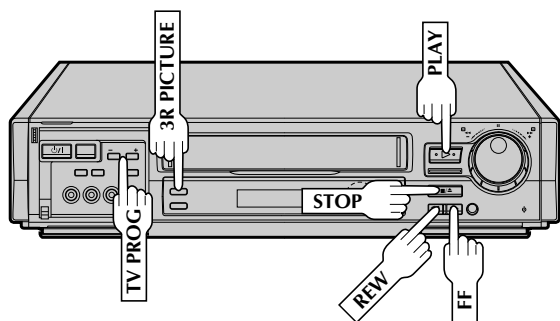

Tape Position Indicator

The tape position indicator appears on screen when, from the Stop mode, you press **FF**, **REW** or perform an Index Search. The position of "■" in relation to "0" (beginning) or "+" (end) shows you where you are on the tape. "O.S.D." (pg. 9) must be set to "ON", or the indicator will not appear.

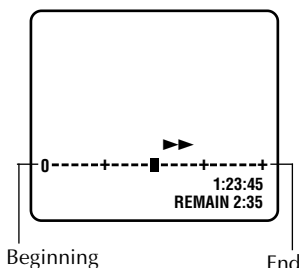

NOTE:

Depending on the type of tape used, there may be times when the indication is not correct.

Manual Tracking

Your video recorder is equipped with automatic tracking control. During playback, you can override this and adjust the tracking manually by pressing the **TV PROG** buttons.

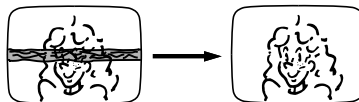

1 OVERRIDE AUTOMATIC TRACKING

Press **SP/LP (||||)** on the remote to engage manual tracking.

2 ADJUST TRACKING MANUALLY

Press **TV PROG +** or **-** to adjust tracking.

3 RETURN TO AUTOMATIC TRACKING

Press **SP/LP (||||)** on the remote to re-engage automatic tracking.

NOTE:

When a new tape is inserted, the recorder enters the automatic tracking mode automatically.

3R Picture

3R(= Resolution and Response Recovery technology) maximises sense of resolution and sharpens image edges to make playback picture look better focused.

1 ACTIVATE 3R PICTURE

Press **3R PICTURE**. The button will light.

- To turn off 3R Picture, press **3R PICTURE** again so that the light goes off.
- Normally it is recommendable to keep 3R Picture ON (with the button lit).
- Depending on the type of tape used, picture quality may be better with 3R Picture set to off.
- If you use this recorder as the player for editing, be sure to turn off 3R Picture before starting.
- The setting will remain effective even though you turn on/off the recorder.

Information On Colour System

You can also record SECAM signals, or play back a MESECAM tape on this recorder. When a MESECAM tape is played back, "MESECAM" appears on the screen for about 5 seconds. MESECAM is the designation for tapes with SECAM signals that have been recorded on a MESECAM-compatible PAL video recorder.

Index Search

Your recorder automatically marks index codes at the beginning of each recording. This function gives you quick access to any one of 9 index codes in either direction.

NOTE:

Before starting, make sure the recorder is in the Stop mode.



1

ACTIVATE INDEX SEARCH

Press **PUSH JOG** < or > (◀◀ or ▶▶) on the remote control. "◀◀ 1" or "▶▶ 1" is displayed on screen and search begins in the corresponding direction.

- To access index codes 2 through 9, press **PUSH JOG** < or > repeatedly until the correct index number is displayed.

Ex.: To locate the beginning of B from the current position, press **PUSH JOG** < twice.
To locate the beginning of D from the current position, press **PUSH JOG** > once.

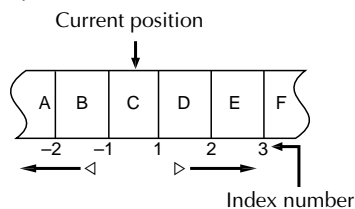

- When the specified index code is located, playback begins automatically.

Instant ReView

Simply by pressing a single button, the recorder power comes on, rewinds, and begins playback of the last timer-recorded programme. If you have several programmes recorded, you can easily access any of them.

NOTE:

Before starting, make sure that the recorder is off and that the Timer mode is disengaged.

1

ACTIVATE INSTANT REVIEW

Press **REVIEW**. The recorder power comes on and the recorder searches for the index code indicating the start of the last timer-recorded programme. Once it's found, playback begins automatically.

The front display panel tells you how many programmes have been recorded. If you have, for example, 3 programmes, "REVIEW" and "3" appear and blink. To watch the first of the 3 programmes, press **REVIEW** three times. The recorder searches and begins playback automatically. You can access a programme as far as 9 index codes away from the current tape position.

NOTE:

Instant ReView is not possible while the recorder is in the Timer mode.

NTSC Playback

Your video recorder is equipped with NTSC circuitry that can play back NTSC tapes on PAL TV.

1

LOAD A CASSETTE

Insert a cassette recorded in NTSC.

2

START PLAYBACK

Press **PLAY**.

- "NTSC" appears on the screen for about 5 seconds.
- Some TVs shrink the picture vertically and place black bars at the top and bottom of the screen. This is not a malfunction on the part of either the video recorder or the TV.
- The picture may roll up and down. This can be corrected using the V-HOLD control found on some TVs. (This cannot be corrected if the TV does not have a V-HOLD control.)
- The counter and tape remaining time readings will be incorrect.
- During search, still, or frame-by-frame playback, the picture will be distorted, and there may be a loss of colour.
- Depending on the type of TV, the top and bottom portions of superimposed displays may be cut off during NTSC playback.

Repeat Playback

Your video recorder can automatically play back the whole tape 20 times repeatedly.



1

START PLAYBACK

Press **PLAY**.

2

ACTIVATE REPEAT PLAYBACK

Press **PLAY** and hold for over 5 seconds, then release.

- The Play indicator (▷) on the display panel blinks slowly.
- The tape plays 20 times automatically, and then stops.

3

STOP PLAYBACK

Press **STOP** at any time to stop playback.

NOTE:

Pressing **PLAY**, **REW**, **FF** or **PAUSE** also stops Repeat Playback.

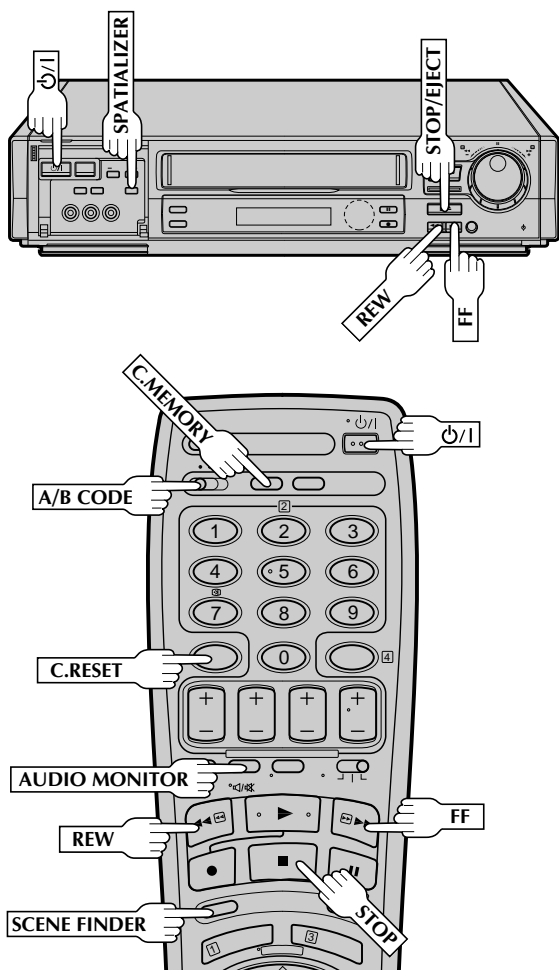

Spatializer®

This feature expands sound field when you play back any stereo source or view a stereo programme while recording it.
*Spatializer® has no effect on recording quality.

1 ACTIVATE SPATIALIZER®

Press **SPATIALIZER**; the current setting will be displayed on the screen for about 5 seconds. Pressing **SPATIALIZER** while the screen shows the display changes the setting.

- To view a stereo programme such as movies or music, select "SPATIALIZER [Speaker Icon]" to create more spacious sound.
- To view a monaural programme, select "SPATIALIZER → ST" which simulates a stereo effect.
- Select "SPATIALIZER OFF" to turn off Spatializer® if the sound becomes unnatural with either "SPATIALIZER [Speaker Icon]" or "SPATIALIZER → ST" selected.
- If your TV is equipped with 3D-PHONIC and if you use both Spatializer® and 3D-PHONIC at the same time, the sound may become unnatural; set either function to "OFF".
- The setting will remain effective even though you turn on/off the recorder.

NOTES:

- Spatializer® is effective only with a stereo TV.
- You can change the Spatializer® setting even though "O.S.D." is set to "OFF".
- The setting cannot be changed during search, still, frame-by-frame playback or slow motion mode.
- When this recorder is used as the player for editing, the recorded audio will correspond to the Spatializer® setting.

Soundtrack Selection

Your video recorder is capable of recording three soundtracks (HI-FI L, HI-FI R and NORM) and will play back the one you select.

During Playback

Pressing **AUDIO MONITOR** (Speaker Icon) changes the soundtrack being played back as follows:

TRACK		USE
Recorder's Front Panel	On-Screen Display	
L + R	HI FI L [Speaker Icon] R	For Hi-Fi stereo tapes
L	HI FI L [Speaker Icon]	For main audio of Bilingual tapes
R	HI FI [Speaker Icon] R	For sub audio of Bilingual tapes
NORM	NORM	For audio-dubbed tapes
L + R + NORM	HI FI NORM	For audio-dubbed tapes

NOTES:

- "L + R" should normally be selected. In this mode, Hi-Fi stereo tapes are played back in stereo, and the NORM track is played back automatically for tapes with only normal audio.
- "O.S.D." must be set to "ON" or the on-screen displays will not appear (☞ pg. 9).

Scene Finder

This function helps you check contents of unlabeled recorded tapes at the touch of a single button.

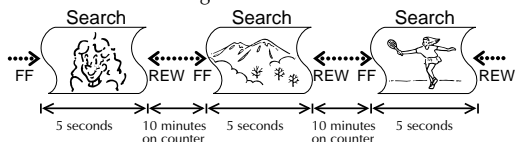

NOTE:

Scene Finder cannot be used when the recorder is in the Record mode.

1

ACTIVATE SCENE FINDER

Press **SCENE FINDER**. The recorder starts forward high-speed search for 5 seconds and then fast-forwards 10 minutes on the counter. This cycle is repeated until the end of the tape is reached.

- To start Scene Finder in the reverse direction, press **SCENE FINDER** and then press the **REW** button within 2 seconds. This cycle is repeated until the beginning of the tape.
- During Scene Finder, the following indications appear on the display panel:



2

STOP SCENE FINDER

Press **STOP**.

NOTES:

- During Scene Finder high-speed search, you can also hear the tape sound. During fast forward or rewind, you hear the current TV sound instead.
- During Scene Finder, the sound can be heard regardless of "TIME SCAN AUDIO" setting. pg. 17.
- Scene Finder does not function during Index Search.

Next Function Memory

You can set your recorder's power to go off automatically after the tape is fully rewound. Before starting, make sure the recorder is in the Stop mode.

For Automatic Power Off After Tape Rewind . . .
 . . . press **REW**, then press **⏪/I** within 2 seconds.

NOTE:

If you want the power to be turned off automatically when the counter reads "0:00:00" (instead of at the beginning of the tape), press **C.MEMORY** so that the "M" mark appears before pressing **REW**.

Remote A/B Code Switching

The remote control is capable of controlling two JVC video recorders independently; one set to respond to the remote control's A code control signals and another set to respond to B code control signals. The remote control is preset to send A code signals because your video recorder is initially set to respond to A code signals. You can easily modify your video recorder to respond to B code signals.

1

REMOVE POWER SUPPLY

Unplug the mains power cord from the mains outlet.

2

SET A/B CODE SWITCH

Set to B.

3

RE-SUPPLY POWER

Plug the mains power cord back into the mains outlet.

4

TURN THE RECORDER ON

Press **⏪/I** on the remote control. The recorder will now only respond to B code signals.

NOTE:

Some TV sets may malfunction in response to the B mode. If this happens, switch back to the A mode.

Counter Memory

Returns to the counter reading of "0:00:00" to conveniently find a specific place on the tape automatically.

1

SET COUNTER MEMORY

Press **C. RESET** during playback at a point you wish to locate later. The counter reads "0:00:00". Then press **C.MEMORY**, and "M" appears in front of the counter digits.

2

ACTIVATE COUNTER MEMORY

When you wish to return to the designated point, press **STOP** and then **REW** or **FF**.

- The tape rewinds or fast-forwards and stops at about 0:00:00 automatically.
- To cancel Counter Memory, press **C.MEMORY** again.

TimeScan

TIME SCAN INDICATOR

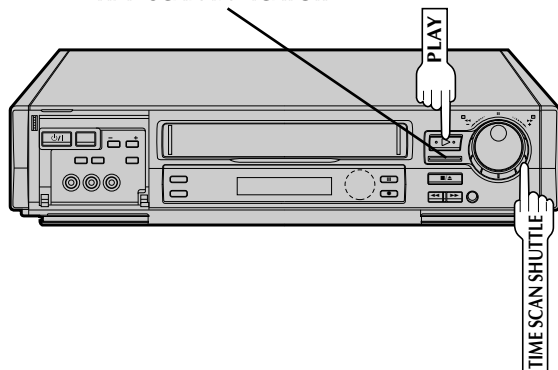

Your recorder is equipped with the TimeScan function. TimeScan allows noise free pictures to be displayed on your TV screen in the forward and reverse search modes. Audio will be played back at normal speed during any of the TimeScan modes (☞ pg. 17). TimeScan allows you to view a program in search mode while listening to the audio.

NOTES:

- "TIME SCAN AUDIO" must be set to "ON", or the sound will not be heard in TimeScan mode. (☞ pg. 17)
- The audio will not synchronize with the video in TimeScan modes.
- In Pause mode 3 seconds (approx.) of audio will be played back repeatedly. (☞ pg. 11)
- In TimeScan search modes some of the audio information will not be played so that the audio can keep up with the video.

Audio signal during TimeScan

Playback tape

①	②	③	④	⑤
---	---	---	---	---

Sound of ①, ③ and ⑤ is heard.

Sound of ② and ④ is not heard.

Output audio signal is normal (monaural) sound.

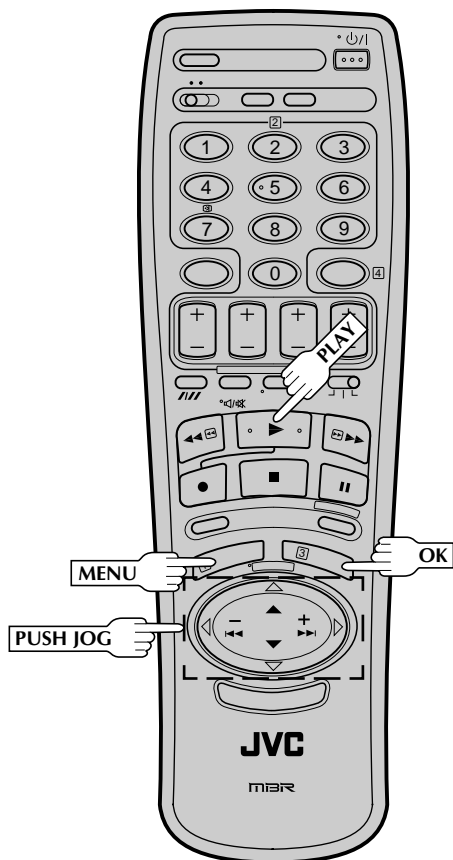

Variable-Speed Search/ Reverse Play

ACTIVATE VARIABLE-SPEED SEARCH

1

During playback or still, turn the recorder's **TIME SCAN SHUTTLE** ring. It remains at that position even after you release it. Each time it passes a click position, the playback speed changes. (Refer to the chart on pg. 17 for playback speeds).

OR

During playback, press **PUSH JOG** ◀ or ▶.

- The more times you press, the faster the playback picture moves.
- To decrease speed, press the button for the opposite direction. (Refer to the chart on pg. 17 for playback speeds).

To resume normal playback, press **PLAY**.

TimeScan

Names of special-effects playback	Reverse				Forward			
	Search	Play	Slow-Motion	*Still	Slow-Motion	Play	Search	
Speed SP	-9x -7x -5x -3x	-1x	-1/6x -1/18x	0	1/18x 1/6x	1x	2x 3x 5x 7x 9x	
Speed LP	-7x -3x		-1/6x -1/18x	0	1/18x 1/6x	1x	2x 5x 9x	
Audio output	Audio is output.		Audio is not output.	Audio is output.	Audio is not output.	Audio is output.		

* Still mode cannot be engaged using the remote control's **PUSH JOG** button. When the still mode is engaged by pressing **PAUSE**, the TIME SCAN indicator does not light even though you can hear TimeScan audio (pg. 11).

- The VCR's TimeScan indicator lights during TimeScan.
- The speed is shown during TimeScan in the upper right corner of the TV screen for approx. 5 seconds. (The display may be distorted.)
- To resume normal playback, press **PLAY**.
- When using the recorder's **TIME SCAN SHUTTLE** ring, the playback speed may not change depending on how far it is turned.
- Picture and audio may become distorted when the recording speed changes. When this happens, resume normal playback once, and then try using TimeScan again.
- The picture may be noisy or there may be a loss of colour when you change the playback speed. (More noise will appear with LP recordings.)
- Noise may appear or the upper part of the picture may be distorted during still, frame-by-frame playback, 2x search of LP recordings, or depending on the tape being used.
- Picture may appear distorted in comparison to normal playback.
- In TimeScan mode there will be a time lag between the video and the audio and noise may appear in the audio signal.
- TimeScan sound quality will differ in comparison to normal playback.
- When the playback direction is reversed, it takes approximately 6 seconds until sound is heard.
- TimeScan does not work with NTSC playback. Picture will be monochrome with an LP-recorded MESECAM tape during TimeScan.

If you don't want to hear TimeScan audio, set "TIME SCAN AUDIO" to "OFF" (See below).

TimeScan Audio

The audio output can be set ON/OFF during TimeScan. Select ON/OFF as required. The default setting is "ON".

- 1 Press **MENU** twice to access the Main Menu screen.
- 2 Move the highlight bar (pointer) to "MODE SET" by pressing **PUSH JOG** $\Delta\nabla$, then press **OK**.
- 3 Move the highlight bar (pointer) to "TIME SCAN AUDIO" by pressing **PUSH JOG** $\Delta\nabla$, then press **PUSH JOG** \triangleright to select "ON" or "OFF".
- 4 Press **MENU** to return to the normal screen.

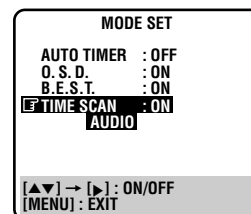

Basic Recording

Turn on the TV and select the VIDEO channel (or AV mode).

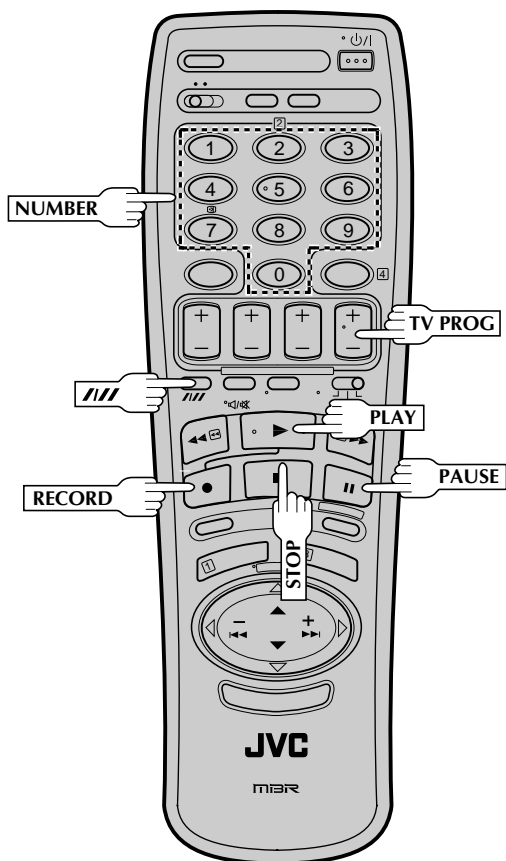
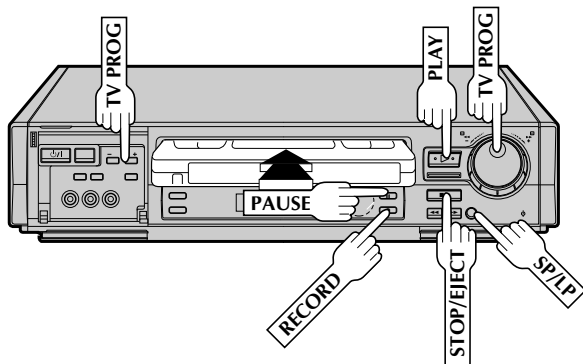

TV signals being received by the recorder's built-in tuner can be recorded onto a video tape. You can "capture" a TV programme using your video recorder.

1 LOAD A CASSETTE

Insert a cassette with the record safety tab intact.

- The counter is reset to 0:00:00 and the recorder power comes on automatically.

2 CHOOSE A PROGRAMME

Press **TV PROG +/-** or the **NUMBER** keys to select the channel you wish to record.

- The **TV PROG** dial can also be used to select a channel.

3 SET TAPE SPEED

Press **/// (SP/LP)**. Check the SP/LP indicator on the recorder display panel to confirm the selected tape speed.

4 START RECORDING

Press and hold **RECORD** and press **PLAY** on the remote control, or press **RECORD** on the recorder.

B.E.S.T. takes place at the beginning of both the first SP and the first LP recording after inserting the cassette (see pg. 20).

5 PAUSE/RESUME RECORDING

Press **PAUSE**. Press **PLAY** to resume recording.

6 STOP RECORDING

Press **STOP** on the remote control or **STOP/EJECT** on the recorder. Then press **STOP/EJECT** to remove the cassette.

Accidental erasure prevention

- To prevent accidental recording on a recorded cassette, remove its safety tab. To record on it later, cover the hole with adhesive tape.

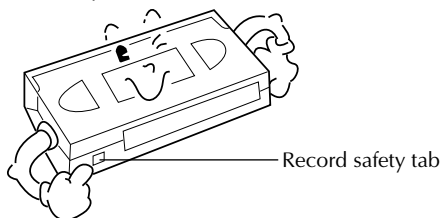

Recording Features

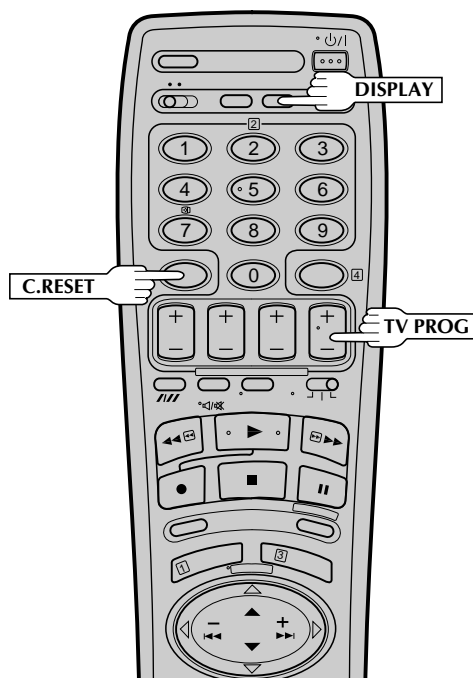
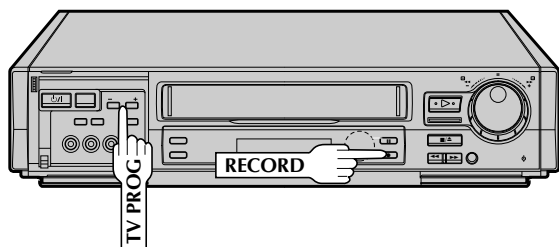

Tape Remaining Time

1

DISPLAY REMAINING TIME

Press **DISPLAY** until the time remaining on the tape appears.

NOTE:

Depending on the type of tape used, there may be times when the tape remaining time reading may not appear right away, or is not correct. "--:--" may sometimes appear, or the display may blink on occasion.

Record One Programme While Watching Another

1

SELECT CHANNEL TO WATCH

Once recording is in progress, all you need to do is to set the channel controls on the TV for the station you wish to view.

- The programme selected with the TV's channel controls appears on the TV screen while the one selected with the recorder's **TV PROG** buttons is recorded on the tape.

Elapsed Recording Time Indication

You can check the exact time of a recording.

1

SET COUNTER DISPLAY

Press **DISPLAY** until a counter reading appears on the display panel.

- By pressing the **DISPLAY** button, you can change the display to show the counter reading, channel position*, clock time or tape remaining time.
* channel position is not displayed during playback.

2

RESET COUNTER

Press **C. RESET** before starting recording or playback.

- The counter is reset to "0:00:00" and shows the exact elapsed time as the tape runs.

Instant Timer Recording (ITR)

This easy method lets you record for from 30 minutes to 6 hours (selectable in 30-min. increments), and shuts the recorder off after recording is finished.

1

START RECORDING

Press **RECORD** on the recorder.

2

ENGAGE ITR MODE

Press **RECORD** again. "O" blinks and 0:30 appears on the front display panel.

3

SET RECORDING DURATION

If you want to record for more than 30 minutes, press **RECORD** to extend the time. Each press extends recording time by 30 minutes.

NOTE:

You can only perform ITR using the **RECORD** button on the recorder's front panel.

B.E.S.T. Picture System

Turn on the TV and select the VIDEO channel (or AV mode).

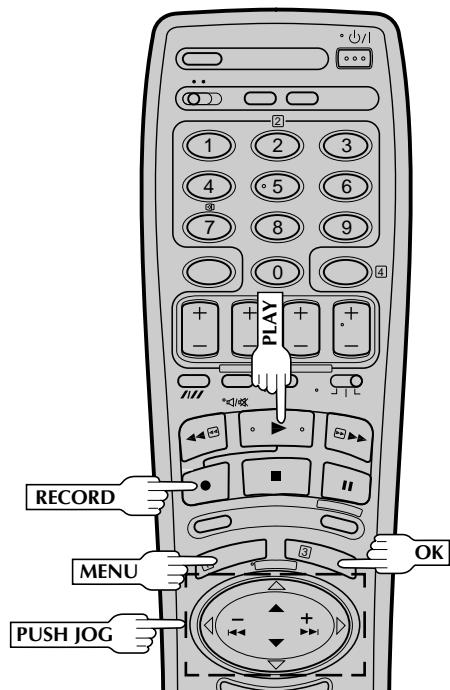
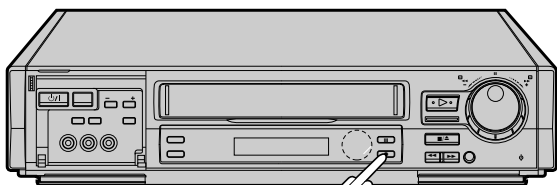

Display Panel Indication



As the tape check progresses, the “— —” marks on the display panel increase upward. Once the "BEST" indicator starts blinking, the check is complete.

The B.E.S.T. (Biconditional Equalised Signal Tracking) system checks the condition of the tape in use during recording and playback, and compensates to provide the highest-possible recording and playback pictures. The default setting for both recording and playback is “ON”.

Recording

1 LOAD A CASSETTE

Insert a cassette with the record safety tab intact.

- The recorder power comes on automatically.

2 ACCESS MAIN MENU SCREEN

Press **MENU** twice.

3 ACCESS MODE SET SCREEN

Move the highlight bar (pointer) to “MODE SET” by pressing **PUSH JOG** $\Delta \nabla$, then press **OK**.

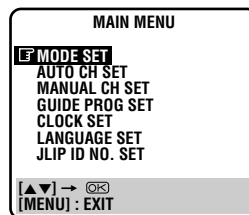

4 CONFIRM B.E.S.T. STATUS

The default setting is “ON”. If this is the case, go to step 5. If not, press **PUSH JOG** ∇ to move the highlight bar (pointer) to “B.E.S.T.”, then press **PUSH JOG** \triangleright to set to “ON”.

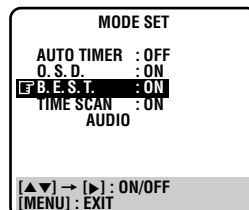

5 RETURN TO NORMAL SCREEN

Press **MENU**.

6 START RECORDING

Press and hold **RECORD** and press **PLAY** on the remote, or press **RECORD** on the recorder.

- The recorder spends approximately 7 seconds assessing the condition of the tape, then begins recording.
- When the "BEST" indicator begins blinking, that means adjustment is complete.
- Pressing the recorder's **RECORD** button while "BEST" is displayed does not start Instant Timer Recording (see pg. 19).

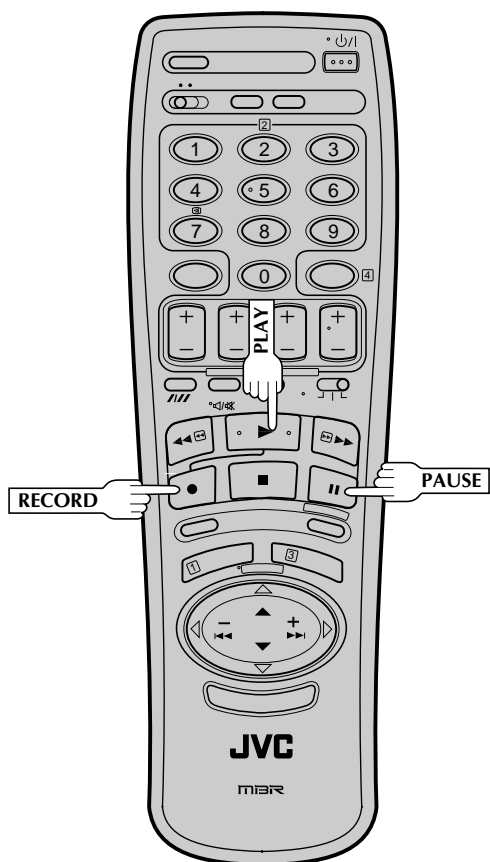
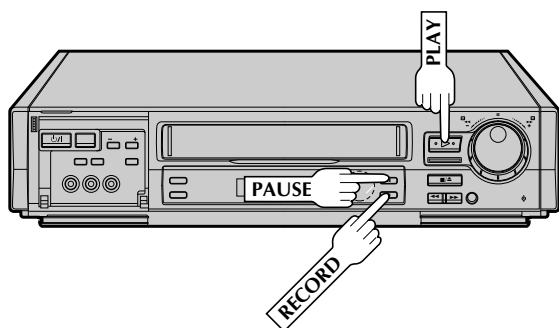

NOTES:

- The B.E.S.T. system works for both SP and LP modes only after a tape has been inserted and the Record mode is first initiated. It does not work during recording.
- In the case of timer recording, the B.E.S.T. system works before recording is initiated.
- Once the cassette is ejected, the B.E.S.T. data is cancelled. The next time the cassette is used for recording, B.E.S.T. is re-performed.

ATTENTION:

Since the B.E.S.T. system works before recording actually starts, there is a delay of approximately 7 seconds after **RECORD** and **PLAY** on the remote are pressed, or **RECORD** on the recorder is pressed. To make sure you record the desired scene or programme in its entirety, first perform the following steps:

- 1) Press and hold **PAUSE** and press **RECORD** to engage the RECORD PAUSE mode.
 - The recorder then automatically checks the condition of the tape and, after approximately 7 seconds, re-enters RECORD PAUSE.
- 2) Press **PLAY** to start recording.
 - If you want to bypass the B.E.S.T. system and begin recording immediately, set "B.E.S.T." to "OFF" in step 4 on page 20.

Playback

The recorder assesses the quality of the tape once you initiate playback.

When watching a tape recorded with "B.E.S.T." set to "ON", it is recommended that you leave B.E.S.T. on during playback as well.

START PLAYBACK

1

Press **PLAY**.



- The recorder adjusts the playback picture quality based on the quality of the tape in use.
- B.E.S.T. is active during Auto Tracking. "BEST" appears blinking on the recorder's display panel.

NOTES:

- When watching a rental tape or one recorded on another video recorder, or when using this recorder as the player for editing, set B.E.S.T. to your preference by performing steps 2 through 5 on page 20.
- "BEST" only appears at the beginning of automatic tracking. Even though it doesn't appear after that, the B.E.S.T. function is operative.

SHOWVIEW Setup

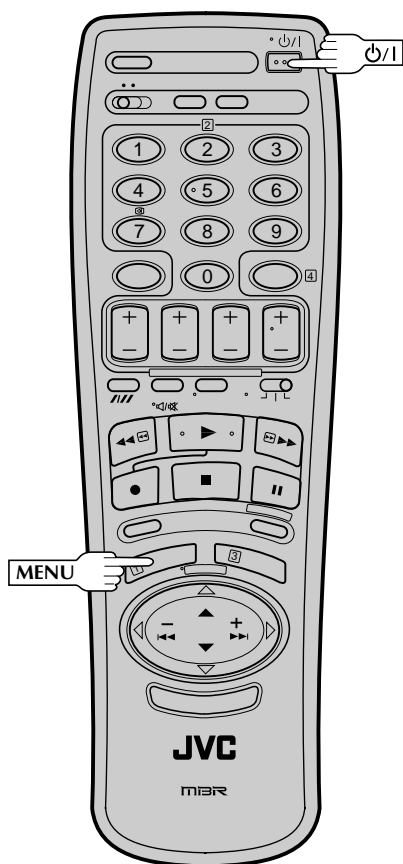
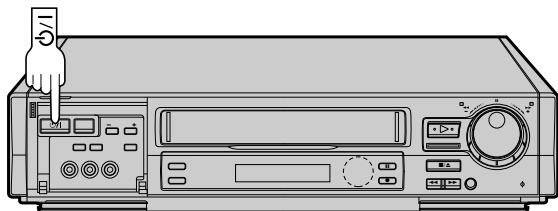

ATTENTION

For a list of Guide Prog. Numbers for Poland, Czech Republic, Hungary, and Russia, refer to page 46 of the instruction manual printed in the corresponding language.

The SHOWVIEW timer programming system eliminates the need to input channel, date, start and stop time data when setting the timer record function. Simply key in the SHOWVIEW number for the TV program you wish to record (found in most TV listings) and the recorder's timer is automatically programmed.

You have to set "Guide Prog." numbers, which are assigned to each station for purposes of SHOWVIEW timer programming, for all the stations stored in your recorder's memory to get proper results.

Before SHOWVIEW setup you must have performed the following procedures:

- Tuner setting (☞ pg. 4, 39)
- Clock setting (☞ pg. 8)

IMPORTANT

Perform the following procedure after Auto Set Up on page 4 and/or the channel setting steps on pages 39 – 42. After setting the Guide Program Numbers, channel positions may be incorrect if you stored or skipped channels. In this case, re-perform Guide Program Number setting.

Guide Program Number Set

MAKE LIST OF STORED STATION NAMES AND CHANNEL POSITIONS

(Ex.)

A Channel position	B Station name
1	ORT
2	RTR

TURN ON THE RECORDER

Press $\psi/|$.

ACCESS MAIN MENU SCREEN

Press MENU twice.

1

2

3

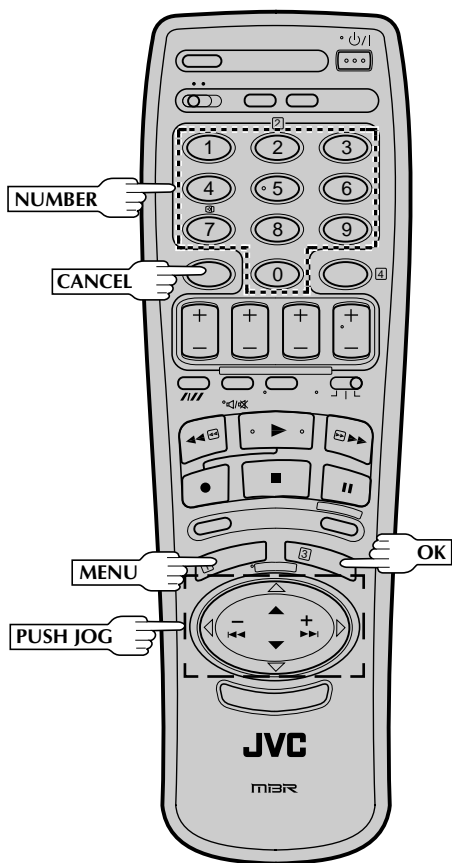

If you already know the Guide Program number for a station . . .

- 1- After step 4, press **PUSH JOG** \triangleright .
 - The GUIDE PROG number begins blinking.
- 2- Enter the Guide Program number using the **NUMBER** keys or **PUSH JOG** $\Delta\nabla$, then press **PUSH JOG** \triangleright .
 - The TV PROG number begins blinking.
- 3- Enter the channel position using the **NUMBER** keys or **PUSH JOG** $\Delta\nabla$, then press **PUSH JOG** \triangleleft .
 - Repeat 2 and 3 as necessary.
- 4- Press **MENU**.

4

ACCESS GUIDE PROG SET SCREEN

Press **PUSH JOG** $\Delta\nabla$ to move the highlight bar (pointer) to "GUIDE PROG SET", then press **OK**. The Guide Prog. Set screen appears.

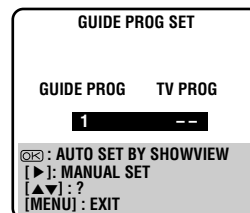
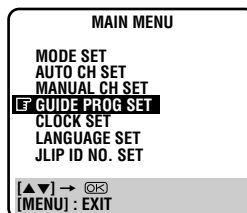

5

ENTER SHOWVIEW NUMBER

Press **OK**, and a cursor appears above "GUIDE PROG". Then, using the **NUMBER** keys, input the SHOWVIEW number (found in most TV listings) of a program scheduled to be broadcast on each station on the list from step 1, starting at the top. If you enter the wrong number, press **CANCEL** to backspace and input the correct number.



When entering a SHOWVIEW number for RTR

6

ENTER CHANNEL POSITION NUMBER

Press **OK**. The Guide Program number, which is assigned to the TV station for the SHOWVIEW number that you entered in step 5, will appear automatically. Input the channel position for the TV station ([A] column of your list in step 1) using **PUSH JOG** $\Delta\nabla$ or the **NUMBER** keys, then press **OK**.

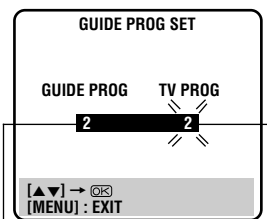

Guide Prog. No.

Channel position

- If you input the SHOWVIEW number of a program that has already aired, "ERROR" appears on screen for a few seconds. Input the correct SHOWVIEW number.
- Repeat steps 5 and 6 as necessary.

7

CLOSE MENU

Press **MENU** and selection is complete.

SHOWVIEW Timer Recording

Before performing SHOWVIEW timer recording:

- Be sure to read "SHOWVIEW Setup" (pg. 22).
- Insert a cassette with the safety tab in place. The recorder will come on automatically.
- Turn on the TV and select the VIDEO channel (or AV mode).

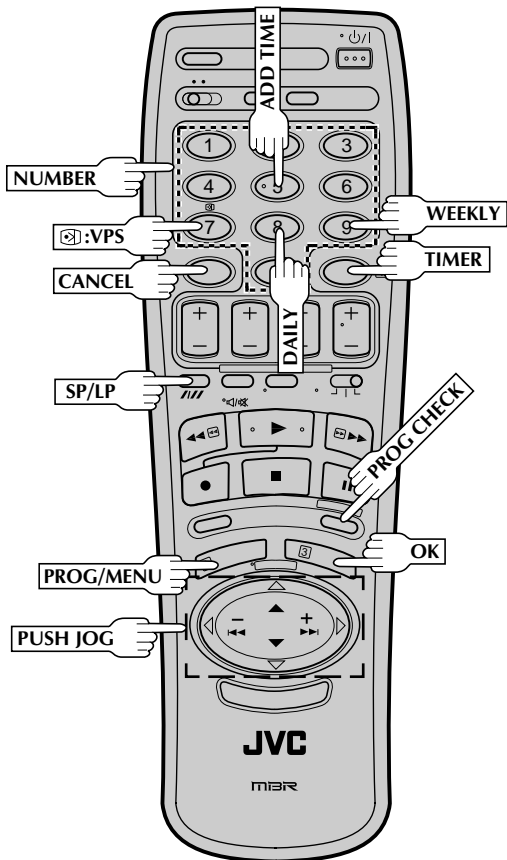
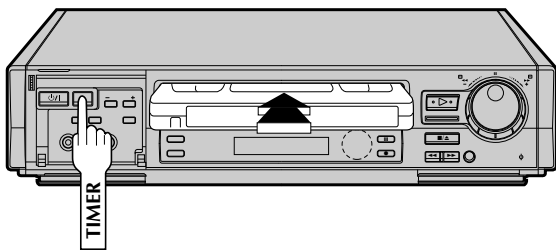

1

ACCESS TIMER PROGRAMMING SCREEN

Press **PROG.**

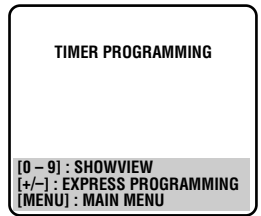

The front display panel looks like this:



2

ENTER SHOWVIEW NUMBER

Press the **NUMBER** keys to enter the SHOWVIEW number of a programme you wish to record.

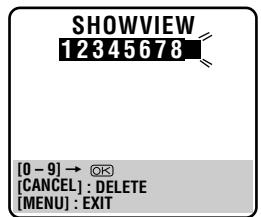

- If you make a mistake, press **CANCEL** to backspace and then input the correct number.

The SHOWVIEW number you enter appears on the front display panel:



The display panel can only show 4 digits at a time.

ATTENTION:

SHOWVIEW Timer Programming cannot be performed correctly for programmes whose SHOWVIEW number start with "0".

3

ACCESS SHOWVIEW PROGRAM SCREEN

Press **OK**, and the SHOWVIEW Program screen appears (if you're just starting out, "P1" appears).

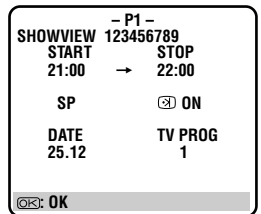

The display panel shows the programme start time.

Pressing **PROG CHECK** changes the display to the programme stop time, then the date and channel position.



IMPORTANT

Be sure to confirm the setting of VPS recording.

- If "ON" is displayed on the screen or "ON" is lit on the display panel, VPS is set to ON.
 - If "OFF" is displayed on the screen or "OFF" is not lit on the display panel, VPS is set to OFF.
- To change the setting, press **VPS** (NUMBER key "7").

Refer to "VPS Recording" on page 29.

- Make sure the channel position number you wish to record is displayed; if not, see "SHOWVIEW Setup" on page 22 and set the Guide Program number for that SHOWVIEW number correctly.
- If the number you entered is invalid, "ERROR" appears on the screen and "Err" appears on the display panel. Press **CANCEL** to backspace and input a valid SHOWVIEW number.
- If "ERROR=GUIDE PROG" appears on the screen, see "ATTENTION – Regarding Guide Program Number Set" on this page.

SET TAPE SPEED

Press **SP/LP** (**///**) to set the tape speed.

RETURN TO NORMAL SCREEN

Press **OK**.

- Repeat steps 1–5 for each additional programme.

ENGAGE RECORDER'S TIMER MODE

Press **TIMER**. The recorder turns off automatically.

ATTENTION

Regarding Guide Program Number Set

"ERROR=GUIDE PROG" appears after performing step 3 on the previous page if the Guide Program number for the SHOWVIEW number you entered has not been set.

- If the recorder is in the stop or rewind or fast-forward mode, the following screen will appear with "--" under "TV PROG" blinking.
- Press the **NUMBER** keys or **PUSH JOG** $\Delta \nabla$ to input the channel position number your recorder receives that station on, then press **OK**.

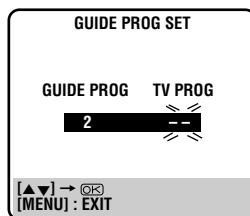

(Ex.) To timer-record a RTR programme with SHOWVIEW * If your recorder receives RTR on the channel position 2, press **OK** after entering "2".

- Press **MENU**, then try again from step 1.
- If the recorder is in a mode other than the above mentioned modes, press **MENU** first and input the correct Guide Program number for that SHOWVIEW number (☞ pg. 22, "SHOWVIEW Setup"), then try again from step 1.

4

5

6

NOTE:

To Delay The Stop Time . . .

. . . press **ADD TIME** (**NUMBER** Key "5") after pressing **OK** in step 3. Each time you press, the Stop time is delayed by 5 minutes (meaning that 5 minutes of recording time is added). You can easily compensate for anticipated programme schedule delays this way.

To Timer-Record Weekly Or Daily Serials . . .

. . . after pressing **OK** in step 3, press **WEEKLY** (**NUMBER** key "9") for weekly serials or **DAILY** (**NUMBER** key "8") for daily serials (Monday–Friday). Either "WEEKLY" or "DAILY" appears on the screen. Pressing the button again makes the corresponding indication disappear.

You can programme this recorder to timer-record as many as 8 programmes. If you try to programme the recorder to record a ninth, "PROGRAM FULL" appears on screen and "FULL" appears on the front display panel. To record the extra programme, you must first cancel any unnecessary programmes (☞ pg. 28).

Regular Timer Programming

Remember, the clock must be set before you can programme the timer (see pg. 8).

Before performing the following steps:

- Insert a cassette with the safety tab in place. The recorder will come on automatically.
- Turn on the TV and select the VIDEO channel (or AV mode).

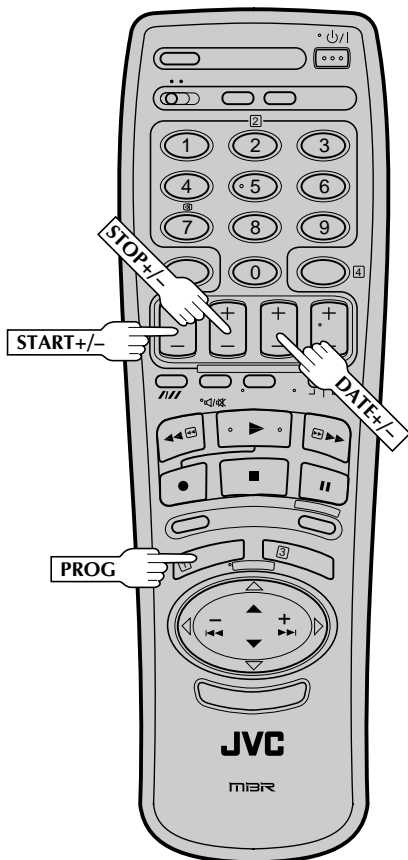
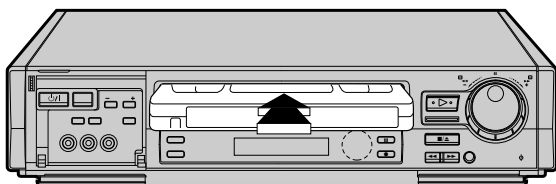

1 ACCESS TIMER PROGRAMMING SCREEN

Press **PROG.**

2 ACCESS PROGRAMME SCREEN

Press **START +/-**. (If you're just starting out, "P1" appears.)

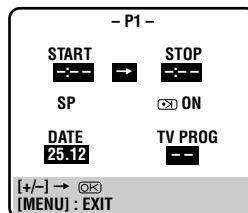

The front display panel looks like this:



3 ENTER PROGRAMME START TIME

Press **START +/-** to enter the time you want recording to start.

- Press and hold **START +/-** to move in 30-minute increments, or press and release repeatedly to move 1 minute at a time.



The front display panel looks like this:



4 ENTER PROGRAMME STOP TIME

Press **STOP +/-** to enter the time you want recording to stop.

5 ENTER PROGRAMME DATE

Press **DATE +/-**. (The current date appears on screen. The date you enter appears in its place.)

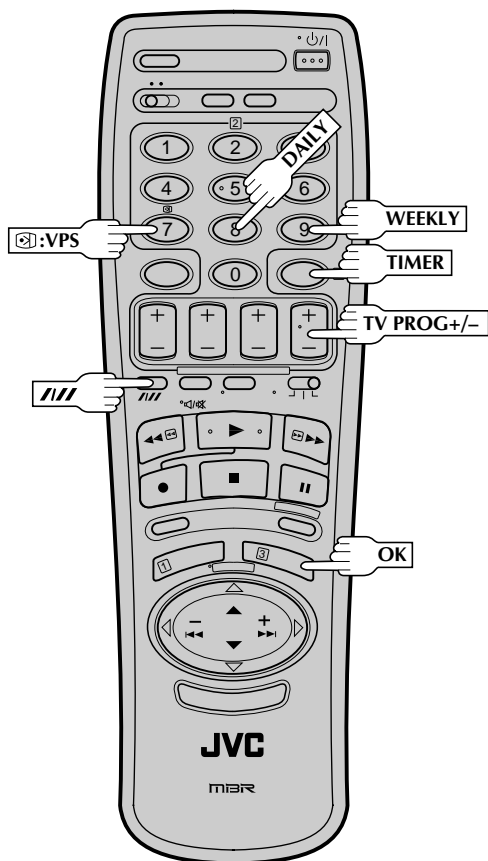

6

ENTER CHANNEL POSITION

Press **TV PROG +/-**.



IMPORTANT

Be sure to confirm the setting of VPS recording.

- If "ON" is displayed on the screen or "ON" is lit on the display panel, VPS is set to ON.

- If "OFF" is displayed on the screen or "OFF" is not lit on the display panel, VPS is set to OFF. To change the setting, press **VPS** (NUMBER key "7").

☞ "VPS Recording" on page 29.

7

SET TAPE SPEED

Press **SP/LP** to set the tape speed.

8

RETURN TO NORMAL SCREEN

After confirming all information is correct, press **OK** and the normal screen appears.

- Repeat steps 1-8 for each additional programme.

9

ENGAGE RECORDER'S TIMER MODE

Press **TIMER**. The recorder turns off automatically.

To Timer-Record Weekly Or Daily Serials . . .

. . . anytime during steps 2 through 8, press **WEEKLY** (NUMBER key "9") for weekly serials or **DAILY** (NUMBER key "8") for daily serials (Monday-Friday). Either "WEEKLY" or "DAILY" appears on the screen. Pressing the button again makes the corresponding indication disappear.

NOTE:

You can programme this recorder to timer-record as many as 8 programmes. If you try to programme the recorder to record a ninth, "PROGRAM FULL" appears on screen. To record the extra programme, you must first cancel any unnecessary programmes (☞ pg. 28).

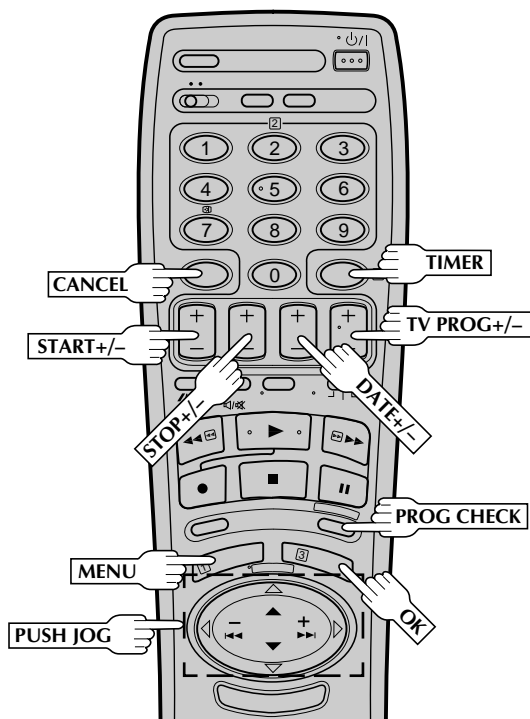

Check And Cancel Programmes

1

ACCESS PROGRAMME DISPLAY AND/OR SCREEN

Press **PROG CHECK**.

- The display panel shows the programme start time. Pressing **OK** changes the display to the programme stop time, then the date and channel position.
- If the recorder is turned on and the TV is set to its VIDEO channel or AV mode, you can check program information on screen.
- Each time you press **PROG CHECK**, the next programme's information appears.

If All Information Is Correct . . .

. . . programming is completed.

If You Wish To Revise Data . . .

. . . with the recorder's power turned on, go to step 2.

If You Wish To Cancel A Program . . .

. . . with the recorder's power turned on, press **CANCEL**. All information you input is deleted.

2

REVISE PROGRAMME INFORMATION

Input the appropriate data using the **START +/-**, **STOP +/-**, **DATE +/-** and **TV PROG +/-** buttons on the remote control.

Auto Timer

When the Auto Timer is set to "ON" the timer is automatically engaged when the recorder power is turned off and automatically disengaged when the recorder is powered back on.

1

ACCESS MAIN MENU SCREEN

Press **MENU** twice.

2

ACCESS MODE SET SCREEN

Press **PUSH JOG** $\Delta \nabla$ to move the highlight bar (pointer) to "MODE SET", then press **OK**.

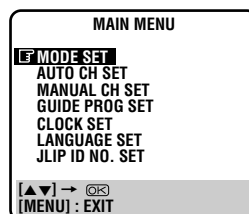

3

SELECT MODE

Press **PUSH JOG** \triangleright to select either "ON" or "OFF".

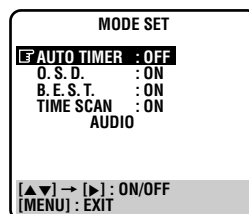

4

RETURN TO NORMAL SCREEN

Press **MENU**.

NOTE:

*For safety, when Auto timer is set to "OFF", all other recorder functions are disabled while the Timer mode is engaged. To disengage the timer, press **TIMER**.*

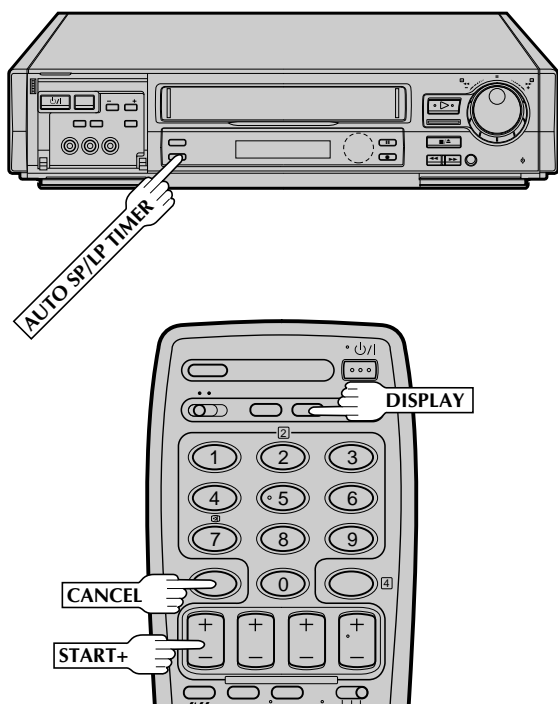

Auto SP/LP Timer

If, when recording in SP mode, there is not enough tape to record the entire programme, the recorder automatically switches to LP mode (with PAL broadcasts) to allow complete recording.

ENGAGE AUTO SP/LP TIMER

1

Press **AUTO SP/LP TIMER** on the recorder front panel. The button lights up.

For Example . . .

Recording a PAL-broadcast program of 210 minutes in length onto a 180-minute tape

Approximately 150 minutes	Approximately 60 minutes
---------------------------	--------------------------

SP mode	LP mode
---------	---------

Total 210 minutes

Make sure you press **AUTO SP/LP TIMER** before performing timer programming.

NOTES:

- The Auto SP/LP Timer feature is not available during ITR (Instant Timer Recording), and the feature will not work properly with any tapes longer than E-180 as well as some tapes of shorter lengths.
- Even if, in step 1, you press **AUTO SP/LP TIMER** and the button lights up, that doesn't mean that the recorder will automatically change from SP to LP mode during the course of the recording. Watch the tape later to confirm.
- If you have programmed the recorder to timer-record 2 or more programs, the second programme and those thereafter may not fit on the tape if you engage the Auto SP/LP Timer mode. In this case, make sure the mode is not engaged, then set the tape speed manually during timer programming.
- There may be some noise at the point on the tape where the recorder switches from SP to LP mode.
- If you perform timer recording with both VPS and the Auto SP/LP Timer activated, and the programme goes beyond its originally scheduled length, there may be times when the programme cannot be recorded in its entirety.

VPS Recording

Now available from some TV stations, VPS (Video Programme System) is a service designed to assure safe, accurate timer recording. With this system, special code signals are transmitted together with the audio/video signals. These code signals control your video recorder and have precedence over advertised times you preset in the timer. This means that your recorder will start and stop recording when the preset TV programmes actually start and end — even if the broadcast time of a preset TV programme is changed.

NOTES:

- When you manually enter programmes (regular timer programming), set the start time (VPS time) exactly as advertised in the TV listing. A different time than advertised will result in no recording.
- VPS recording is not possible in areas where no TV station transmits VPS signals.
- VPS recording is also possible when a satellite tuner or a cable system is connected to the AV2 IN connector on your recorder.
- VPS recording is also possible via the AV1 IN/OUT connector and the front panel connectors.

How to check if the station being received transmits a VPS signal

- 1 Press **DISPLAY** until the channel position appears on the display panel.
- 2 Hold down **START +** for about 5 seconds.
 - "⊗" appears blinking on the display panel. If a VPS signal is detected from the station, "⊗" will stop blinking.
 - If no VPS signal is detected from the station, "⊗" will blink at a slower rate.
- 3 Press **DISPLAY** or **START +** again to return to normal display.

Timer Warning

If you have programmed your recorder to timer-record a programme or a series of programmes, a warning appears on screen to tell you that the recording is to start in 5 minutes.

— WARNING —
TIMER RECORDING
TO START SOON
[CANCEL]

NOTES:

- The warning only appears if you're not in the Timer mode at that time.
- If this recorder is being used as the player for tape dubbing, the warning screen is recorded on the tape in the other video recorder.

The warning blinks for the entire 5 minutes leading up to the start of timer recording. To clear the display, press **CANCEL**.

TV Multi-Brand Remote Control

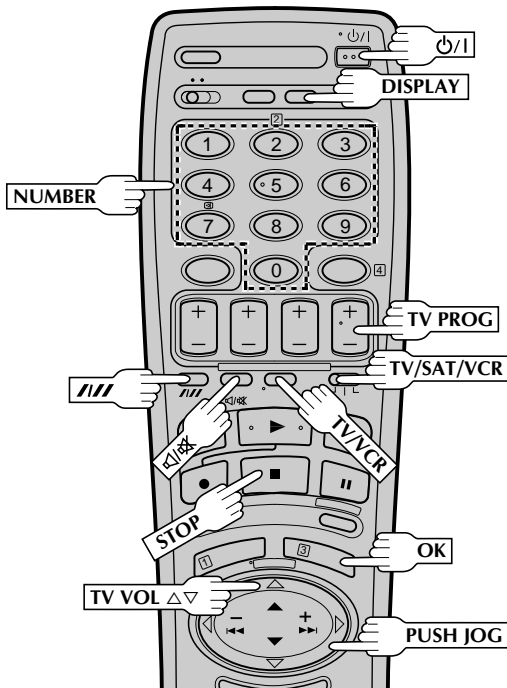

Control Your TV Using Additional Buttons

The **NUMBER** keys on the remote can also be used to select the TV's channel by setting the remote control to the TV mode.

- 1 Set the **TV/SAT/VCR** switch to TV.
 - 2 Use the **NUMBER** keys, and the **///** (Digit Entry) button, the **PUSH JOG** button, the **DISPLAY** button or the **OK** button to select the TV's channel.
- With televisions under Code 01, 02, 03, 04, 06, 07, 09, 10, 13, 14 or 22, the **///** button corresponds to the 1-digit/2-digit entry switching button (often labelled -/-) of your TV's remote control.
 - With televisions under Code 01, 11 or 12, the **PUSH JOG** < button corresponds to the 10 + button, and the **PUSH JOG** > button corresponds to the 20 + button of your TV's remote control.
 - With televisions using Code 12, the **DISPLAY** button corresponds to the 30 + button.
 - With televisions using Code 09, the **OK** button corresponds to the ENTER button of your TV's remote control.

NOTE:

The way these buttons are used is determined by your TV. Use these buttons as instructed for your TV's remote control.

Your remote control can operate the basic functions of your TV set. In addition to JVC TVs, other manufacturer's TVs can also be controlled by setting the appropriate switch on the remote control.

Before you start . . .

- Turn on the TV using its remote control.
- Set the remote control's **TV/SAT/VCR** switch to TV.

1 SET TV BRAND CODE

Refer to the chart below. While holding down **POWER**, enter your TV's brand code using the **NUMBER** keys, then press **STOP**.

- JVC has four codes. If the TV does not function with one code, try entering another.
- You don't have to repeat this step until you replace your remote control's batteries.

2 TRY OPERATING TV

Press **POWER** on the remote to turn the TV off. If it goes off, try other operations.

- The **POWER** button, **TV/VCR** button, **TV PROG +/-** button, **TV VOL +/-** button and **MUTE** button on the remote can all be used to operate the TV.
- To return the remote to video recorder control, set its **TV/SAT/VCR** switch to VCR.

IMPORTANT

Although the provided remote control unit is compatible with JVC televisions, as well as many other models, it may not work with your TV, or in some instances, may have limited function capability.

TV BRAND NAME	CODE
JVC	01, 02, 03, 04
BRANDT	05
NORDMENDE	05
SABA	05
TELEAVIA	05
TELEFUNKEN	05
THOMSON	05
FERGUSON	06
PHILIPS	07
SAMSUNG	07, 19
BLAUPUNKT	08
GRUNDIG	08
SONY	09
PANASONIC	10
GRAETZ	11
ITT	11
LUXOR	11
SALORA	11
SELECO	11
MIVAR	12
HITACHI	13
TOSHIBA	14
MITSUBISHI	15
FINLUX	16
NOKIA	17
SHARP	18
FUNAI	20
GOLDSTAR	21
NEC	22

Satellite Tuner Multi- Brand Remote Control

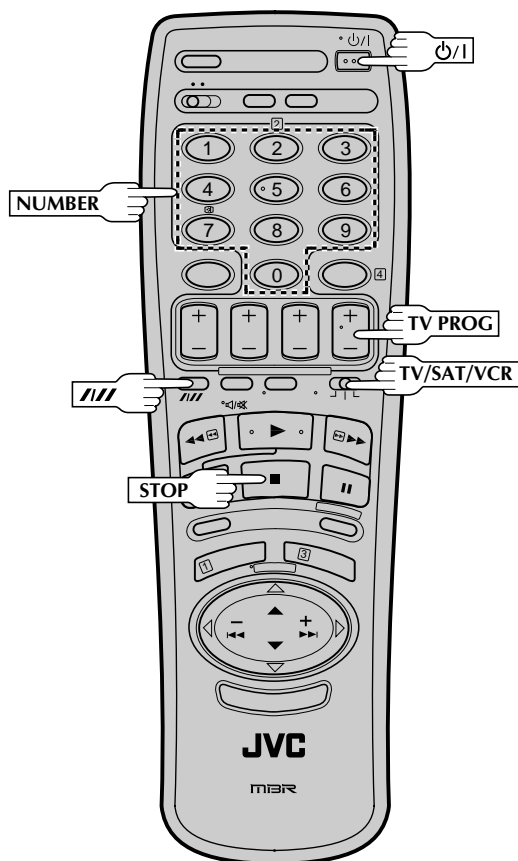

Your remote control can operate the basic functions of your satellite tuner set. In addition to JVC satellite tuners, other manufacturer's satellite tuners can also be controlled by setting the appropriate switch on the remote control.

Before you start . . .

- Turn on the satellite tuner using its remote control.
- Set the remote control's TV/SAT/VCR switch to SAT.

1 SET SATELLITE TUNER BRAND CODE

Refer to the chart below. While holding down P/I , enter your satellite tuner's brand code using the **NUMBER** keys, then press **STOP**.

- Some satellite tuner brands have more than one code. If the satellite tuner does not function with one code, try entering another.
- You don't have to repeat this step until you replace your remote control's batteries.

2 TRY OPERATING SATELLITE TUNER

Press P/I on the remote to turn the satellite tuner off. If it goes off, try other operations.

- The P/I button, **TV PROG +/-** button, **NUMBER** buttons on the remote can all be used to operate the satellite tuner.
- The **NUMBER** buttons will not work with JVC satellite tuners using code 13.
- With satellite tuners using Code 16, the **///** button corresponds to the ENTER button of your satellite tuner's remote control.
- To return the remote to video recorder control, set its **TV/SAT/VCR** switch to VCR.

IMPORTANT

Although the provided remote control unit is compatible with JVC satellite tuners, as well as many other models, it may not work with your satellite tuner, or in some instances, may have limited function capability.

SATELLITE TUNER BRAND	CODE
JVC	13, 14
AMSTRAD	01, 02, 03, 04
SIEMENS	05
GRUNDIG	05, 06
KATHREIN	05, 11, 12
PACE	06, 08
PHILIPS	07
ITT	09
NOKIA	09
SKYMASTER	10
RFT	10
MASPRO	11
BT	13
PANASONIC	15
JERROLD	16

Edit To Or From Another Video Recorder

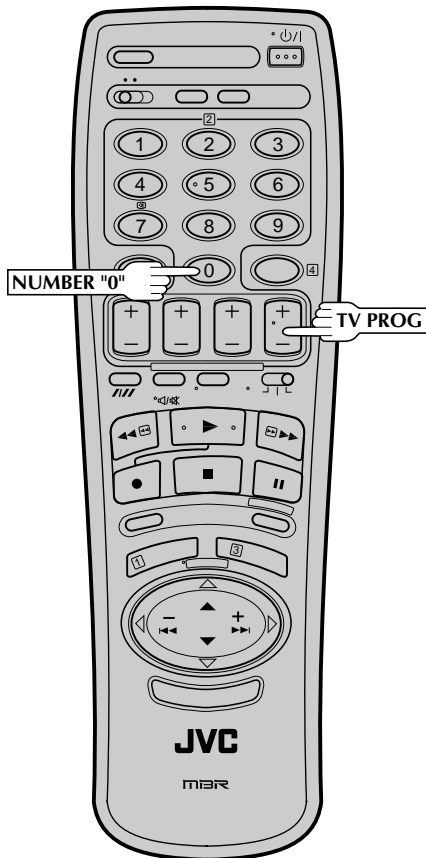

You can use your video recorder as the source player or the recording deck.

1 MAKE CONNECTIONS

Connect the player's 21-pin SCART (AV) connector to the recorder's 21-pin SCART (AV) connector as illustrated on page 33.

When Using Your Video Recorder As The Source Player . . .

. . . connect its AV1 IN/OUT connector to the recording deck.

When Using Your Video Recorder As The Recording Deck . . .

. . . connect its AV2 IN or AV1 IN/OUT connector to the source player.

2 SET RECORDING DECK'S INPUT MODE

Set to AUX. With this video recorder, press **NUMBER** key "0" and/or **TV PROG** to select depending on the connector being used — "AU-1" for the AV1 IN/OUT connector, or "AU-2" for the AV2 IN connector.

3 START SOURCE PLAYER

Engage its Play mode.

4 START RECORDING DECK

Engage its Record mode.

NOTES:

- All necessary cables can be obtained from your dealer.
- If you use this recorder as the player for editing, be sure to turn off 3R Picture before starting. (☞ pg. 12)

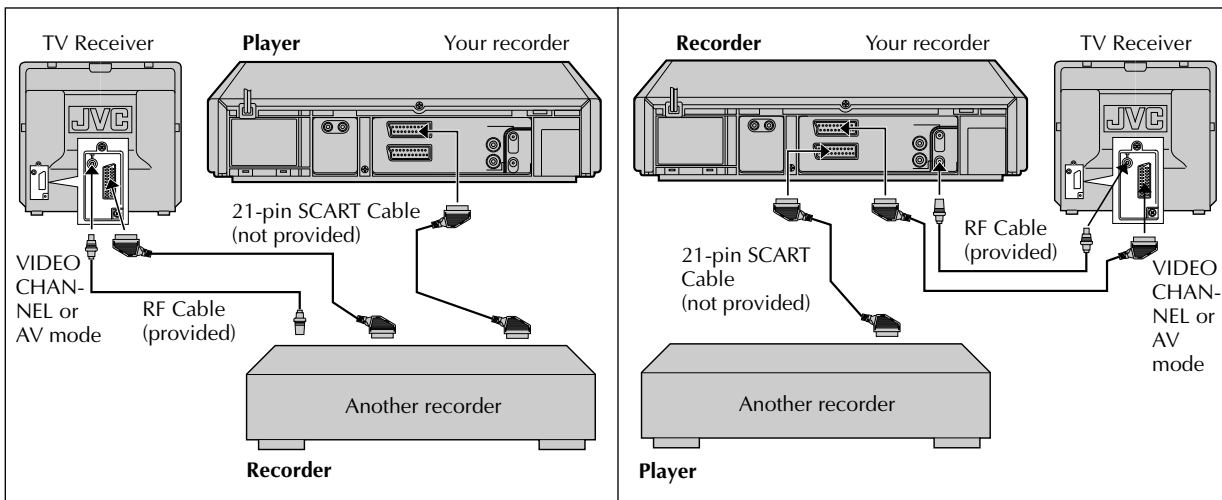

If another recorder has no 21-pin SCART connector

When connecting the AV cable, use the input and/or output cable adapter as illustrated below.

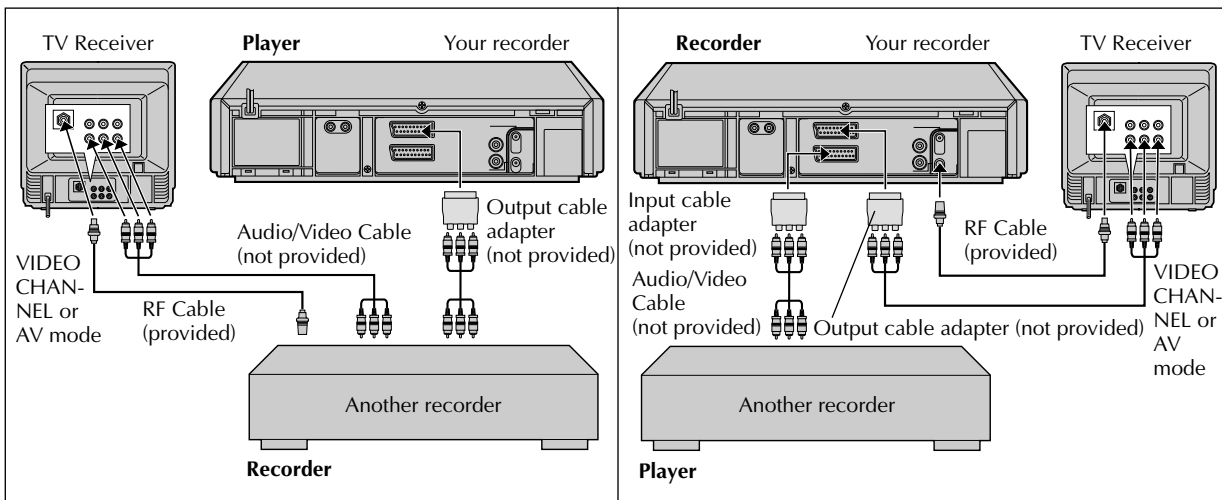

Edit From A Camcorder

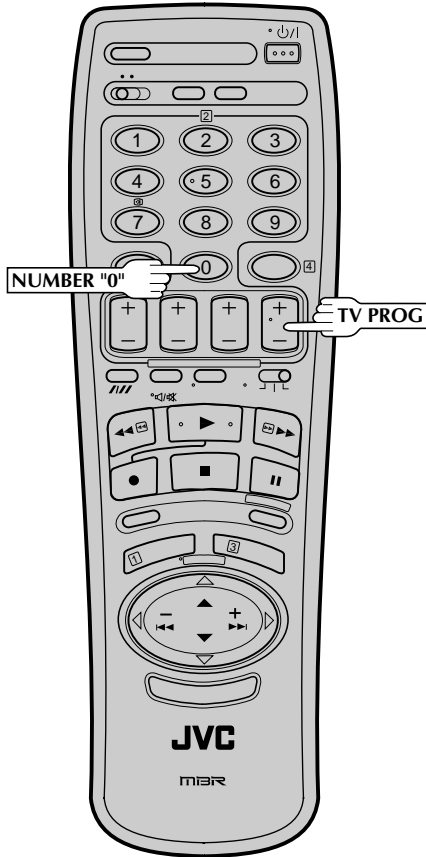

You can use a camcorder as the source player and your video recorder as the recorder.

- 1 MAKE CONNECTIONS**
Connect the camcorder's AUDIO/VIDEO OUT connectors to the recorder's front panel AUDIO/VIDEO input connectors.
 - When using a monaural camcorder, connect its AUDIO OUT connector to the AUDIO IN L input connector on your recorder.
 - When a Master Edit Control-equipped JVC camcorder is used, the camcorder is capable of controlling the recorder. Refer to the camcorder's instruction manual for operating procedure.
- 2 SET RECORDER'S INPUT MODE**
Press **NUMBER** key "0" and/or **TV PROG** so that "F-AU" appears in place of a channel position number.
- 3 START CAMCORDER**
Engage its Play mode.
- 4 START RECORDER**
Engage its Record mode.

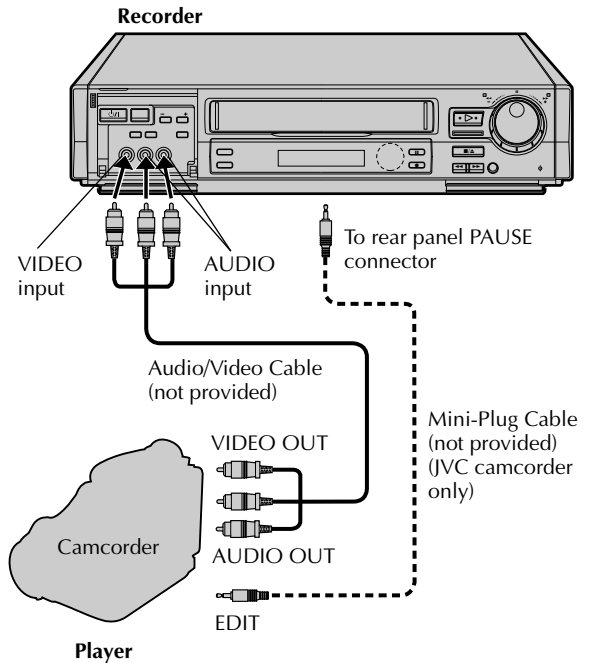

Audio Dubbing

Audio dubbing replaces the normal audio sound of a previously recorded tape with a new soundtrack.

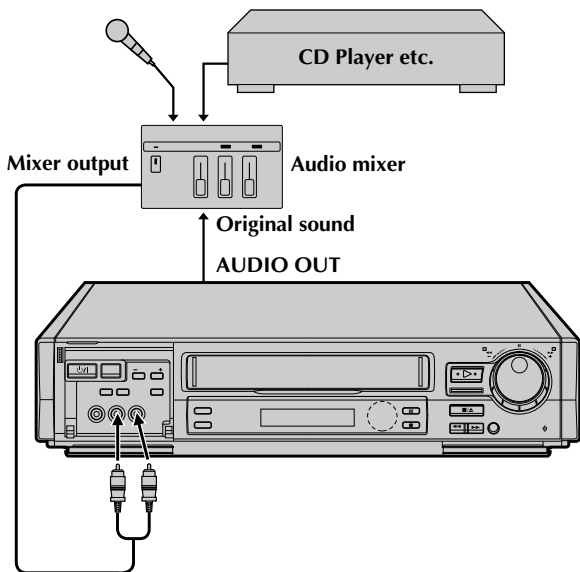
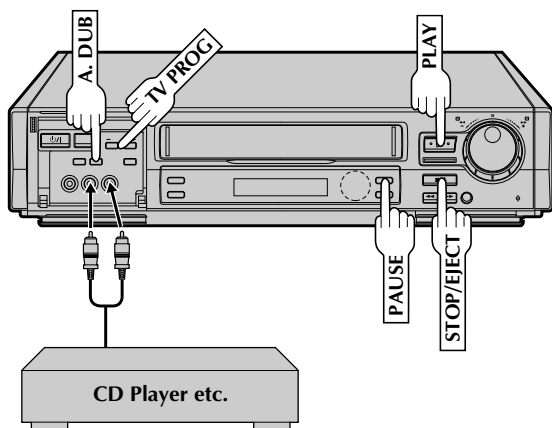
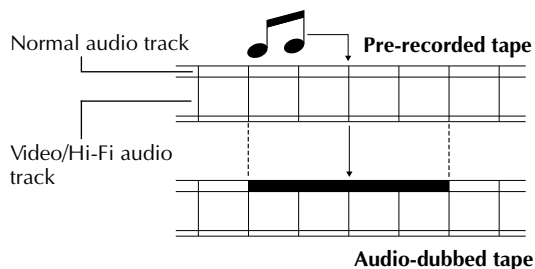

NOTES:

- When monitoring the sound during Audio Dubbing, the normal soundtrack is automatically selected. If you wish to hear the mixed sound (Hi-Fi + Normal soundtracks), press **AUDIO MONITOR** on the remote control to select "L+R+NORM" (☞ pg. 14).
- Audio dubbing stops automatically when the counter reaches "0:00:00", and the recorder enters the Play mode. Check the counter reading before dubbing.
- Audio dubbing is also possible using the rear panel AV1 IN/OUT or AV2 IN connector. When using these connectors, make sure to select the correct input mode in step 2.
- Audio dubbing cannot be performed on a cassette that has had its record safety tab removed.
- When playing back an audio-dubbed tape, press **AUDIO MONITOR** on the remote control to select the soundtrack you wish to hear (☞ pg. 14).

1 MAKE CONNECTIONS

Connect an audio component to the AUDIO IN L + R connectors on the recorder's front panel.

- When connecting monaural equipment, use only the recorder's AUDIO IN L connector.

2 SET INPUT MODE

Press **NUMBER** key "0" and/or **TV PROG** so that "F-AU" appears in place of a channel number.

3 LOCATE START POINT

Press **PLAY** to start playback of the tape in your recorder, and press **PAUSE** when you find the point where you want to start dubbing.

4 ENGAGE AUDIO DUBBING

Press **A. DUB**.

- Your recorder enters the Audio Dubbing Pause mode. ("O" blinks, "▷" and "□" light up on the front display panel.)
- To perform audio dubbing with audio mixing, press **AUDIO MONITOR** on the remote control to select "L + R" at this point. *Audio dubbing with audio mixing is not possible if you're using a monaural audio component, or if you don't have an audio mixer.

5 START DUBBING

Engage the audio component's Play mode, then press **PLAY** to start the tape in your recorder. Audio dubbing begins at this point.

- "O" blinks and "▷" is displayed on the front display panel.
- To stop dubbing temporarily, press **PAUSE**. Press **PLAY** to resume dubbing.

6 END AUDIO DUBBING

Press **STOP/EJECT** to stop the tape in your recorder, and engage the audio component's Stop mode.

Insert Editing

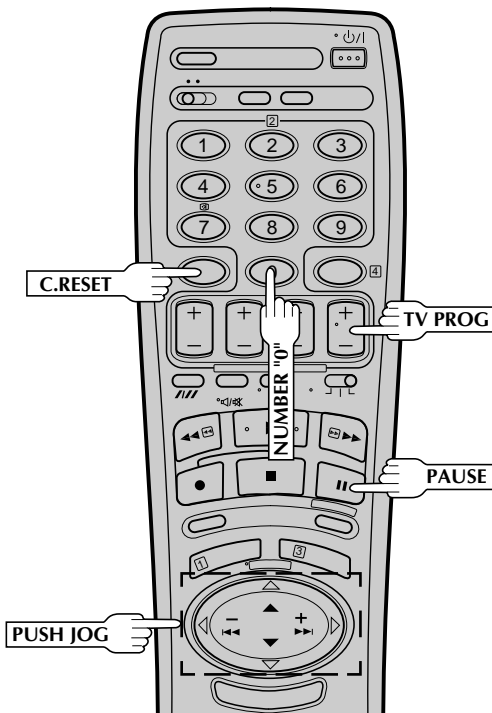
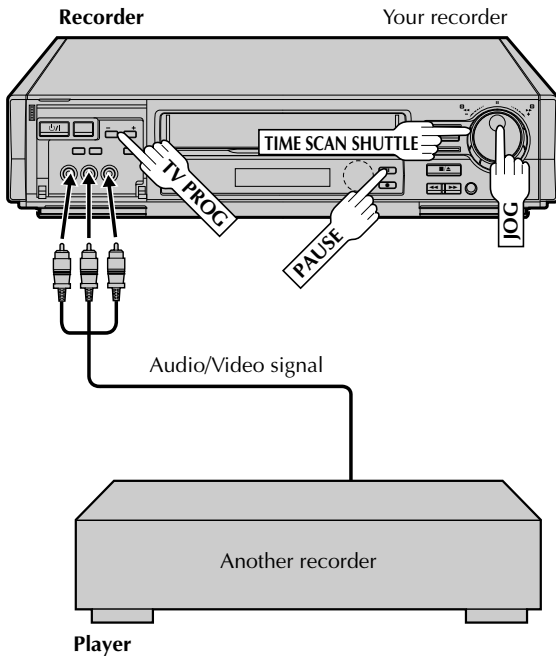

Insert editing replaces part of the recorded scene with new material. Both the picture and Hi-Fi audio soundtrack are replaced with new ones, while the normal audio soundtrack remains unchanged. If you wish to change the normal audio track as well, use the audio dubbing function simultaneously. Use your video recorder as the recorder.

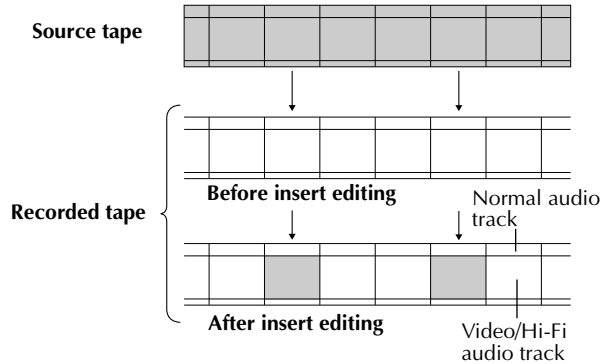

MAKE CONNECTIONS

1 Connect the player's VIDEO OUT and AUDIO OUT connectors to your recorder's VIDEO IN and AUDIO IN on the front panel.

SET INPUT MODE

2 Press **NUMBER** key "0" and/or **TV PROG** so that "F-AU" appears in place of a channel number.

LOCATE END POINT

3 Load the recording cassette into your recorder, and play it back to determine the edit-out point (the end of the segment to be replaced) using the **JOG/TIME SCAN SHUTTLE** controls or **PUSH JOG** ◀▶ and **PAUSE**.

RESET THE COUNTER

4 Press **C.RESET** to change the counter display to "0:00:00".

LOCATE START POINT

5 Determine the edit-in point (the beginning of the segment to be replaced) using the **JOG/TIME SCAN SHUTTLE** controls or **PUSH JOG** ◀▶ and **PAUSE**.

- Be sure to engage the Still mode at the edit-in point.

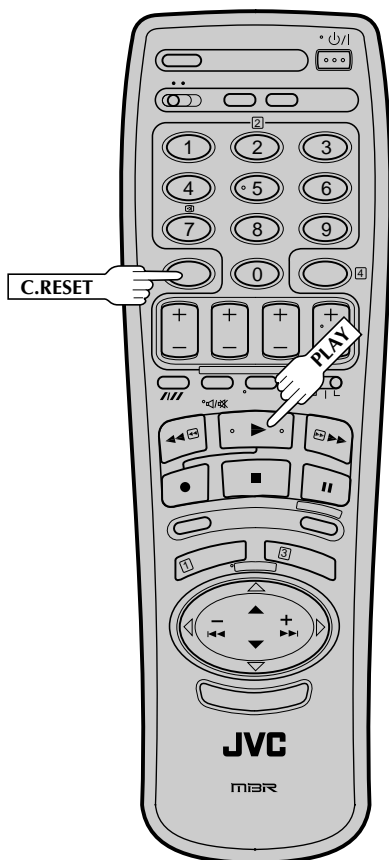
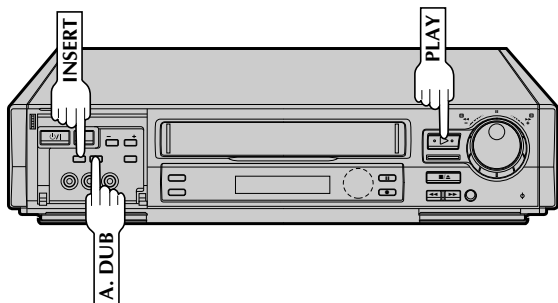

6 ENGAGE INSERT EDITING

Press **INSERT**.

- Your recorder enters the Insert-Pause mode. ("O", "▷" and "□□" light up on the front display panel.)
- The TV screen changes from the still picture to the input source you are going to record.

7 START EDITING

Load the source cassette and play back the segment that is to be inserted. When you reach the start of the section of the source tape that you wish to insert, press **PLAY** to start the tape in your recorder; Insert Editing begins at this point.

- "O" and "▷" are displayed on the front display panel.

8 END INSERT EDITING

At counter "0:00:00", Insert Editing will stop automatically while the tape continues running in the Play mode. If you wish to stop Insert Editing before the specified edit-out point, press **C.RESET**.

FOR AV INSERT EDITING

If you want to replace the picture, Hi-Fi audio soundtrack and normal audio soundtrack all at the same time...

In step 6 above, after you press **INSERT**, press **A. DUB** also. ("O" and "▷" blink and "□□" lights up on the front display panel.)

NOTES:

- Suitable leads can be obtained from your dealer.
- Insert editing is not possible with cassettes whose safety tab has been removed.
- When insert editing is performed on a tape that has been recorded on another video recorder, the inserted portion may appear distorted.
- In insert editing, the recording speed (SP/LP) is determined by the previous recording to be replaced. If the previous recording's speed changes within a single edit, the inserted picture will be distorted at the switching point.
- A small portion of the recording which precedes an insert edit may become erased.
- Insert Editing is also possible using the rear panel AV1 IN/OUT or AV2 IN connector. When using these connectors, make sure to select the correct input mode in step 2.

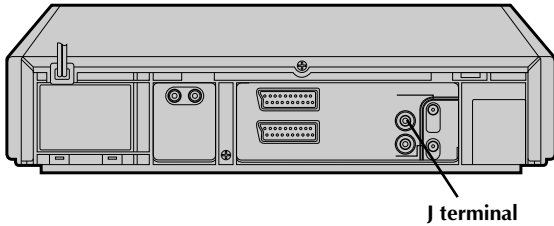

J terminal

J Terminal (JLIP(Joint Level Interface Protocol) Connector)

The J Terminal is used to connect the recorder to a personal computer or similar device to allow computerized control of the recorder during editing and certain other operations.

Examples:

- Enables Random Assemble Editing of up to 99 segments with the optional JLIP PLAYER PACK, using this recorder as the playback unit. (Use this recorder's PAUSE connector in lieu of the EDIT jack.)
- Allows you to capture still images from the recorder into a personal computer with the optional JLIP VIDEO CAPTURE BOX.

For further details consult your nearest JVC dealer.

JLIP ID Number

Your recorder has its own JLIP ID number. This ID number must be unique when your recorder is connected to another device via its J terminal. The ID Number is preset to "1" at the factory. You can change this number to any number between "1" and "99". If it is necessary to change the JLIP ID number perform the following steps.

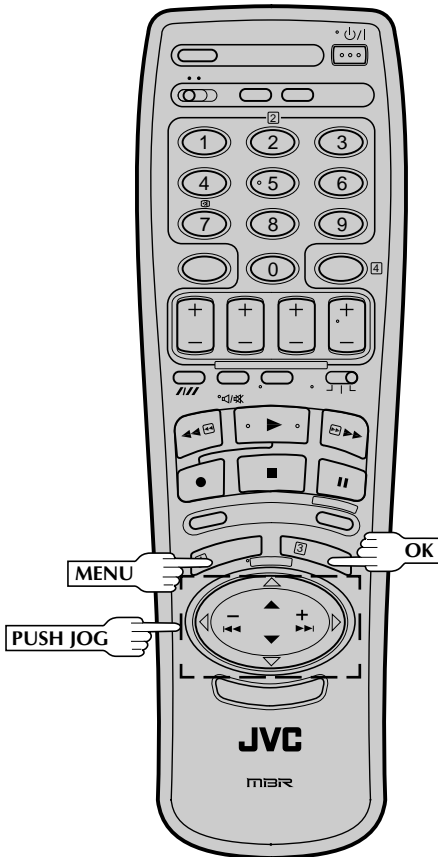

ATTENTION

After you change your recorder's JLIP ID number, control signal transmission may not work properly. If this happens, turn off the recorder's power off once, then turn it back on and try again.

1 ACCESS MAIN MENU SCREEN

Press **MENU** twice.

2 ACCESS JLIP ID NO. SET SCREEN

Press **PUSH JOG** $\Delta\nabla$ and move the highlight bar (pointer) to "JLIP ID NO. SET", then press **OK**.

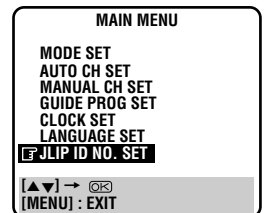

3 SET JLIP ID NUMBER

Press **PUSH JOG** $\Delta\nabla$ to enter the desired ID number.

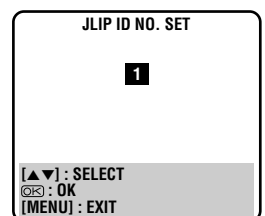

4 RETURN TO NORMAL SCREEN

Press **MENU** or **OK**.

4

Turn on the TV and select the VIDEO channel (or AV mode).

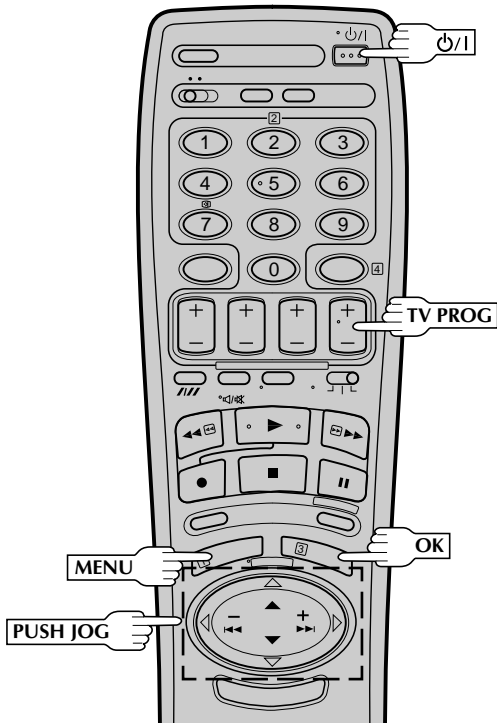

IMPORTANT

Perform the following steps only if auto channel set has not been set correctly by Auto Set Up function (pg. 4) or if you have moved to a different area or if a new station starts broadcasting in your area.

Your recorder needs to memorise all necessary stations in channel positions in order to record TV programmes. Auto Channel Set automatically assigns all receivable stations in your area so that you can call them up with the TV PROG buttons without going through any vacant channels.

Auto Channel Set

- 1** **TURN ON THE RECORDER**
Press **Power**.
- 2** **ACCESS MAIN MENU SCREEN**
Press **MENU** twice.

PERFORM AUTO CHANNEL SET

3

Press **PUSH JOG** to move the highlight bar (pointer) to "AUTO CH SET", then press **OK** to initiate Auto Channel Set.

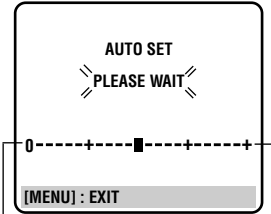

- The Auto Set screen appears, and remains on screen while the recorder searches for receivable stations. As Auto Channel Set progresses, the "█" mark on the screen moves from left to right. Wait until the screen as shown in step 4 appears.

4

VIEW CONFIRMATION SCREEN

The stations your recorder located appear on a Confirmation screen — channel positions (PR) and channels (CH). To view the next page of the listing, press **PUSH JOG**. The blueback screen and the program currently being broadcast by the blinking station appear alternately for 5 seconds each.

PR	CH	ID	PR	CH	ID
01	26	---	08	---	---
02	27	---	09	---	---
03	28	---	10	---	---
04	29	---	11	---	---
05	30	---	12	---	---
06	31	---	13	---	---
07	C08	---	14	---	---

C: Cable

- Even though the displayed channel number may not match the actual local channel number, the picture being received will not be affected.

RETURN TO NORMAL SCREEN

5

Press **MENU**.

- Using the Confirmation screen, you can skip or add channel positions, enter station names (ID— pg. 43) and perform other operations. Refer to pages 40 – 43 for the procedures.

NOTE:

Fine tuning is performed automatically during Auto Channel Set. If you want to perform it manually, refer to page 42.

IMPORTANT

- If no sound accompanies the picture on some channels that have been stored by Auto Channel Set, the TV system setting for those channels may be incorrect. Select the appropriate TV system for those channels. "TV System Selection – When you see the picture but hear no audio" on page 41.
- Since your video recorder memorizes all detected stations even if the reception condition is poor, some of those stored stations may produce a noisy picture. To delete those stations, "Delete A Channel" on page 41.

Storing Channels Manually

Store channels that were not stored during Auto Set Up (☞ pg. 4) or Auto Channel Set (☞ pg. 39).

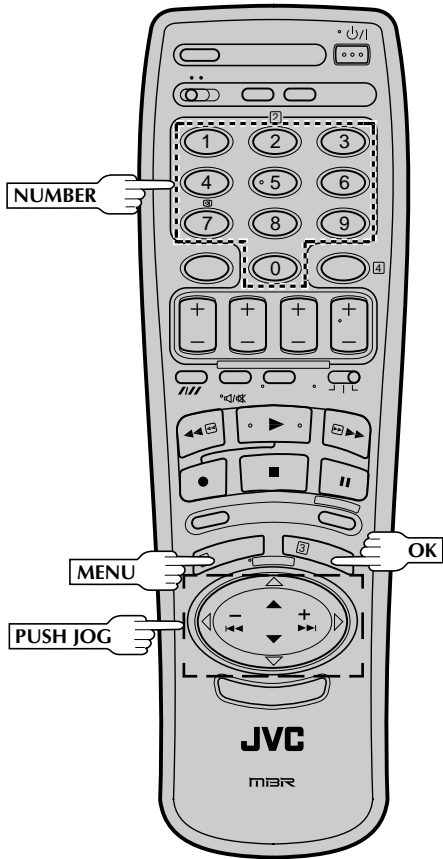

If the picture for the entered channel number does not appear . . .

- 1- Press **PUSH JOG** ▷ twice.
 - The channel number begins blinking.
- 2- Hold down **PUSH JOG** △ until the picture appears.
 - If not picture appears even if you hold down the button for more than 10 seconds, try the **PUSH JOG** ▽ button until the picture appears.
 - The displayed channel number will differ from the one you have entered.

Major Countries	TV System
Austria, Denmark, Finland, Holland, Italy, Norway, Spain, Switzerland, Sweden, Germany, Egypt	B/G
China, Mongolia, Rumania, Bulgaria, Czech Rep., Slovakia, Hungary, Poland, Russia	D/K

1 ACCESS MAIN MENU

Press **MENU** twice.

2 ACCESS CONFIRMATION SCREEN

Press **PUSH JOG** △▽ to move the highlight bar (pointer) to "MANUAL CH SET", then press **OK**. The Confirmation screen appears.

3 SELECT POSITION

Press **PUSH JOG** △▽◁▷ until an open position in which you want to store a channel begins blinking, then press **OK**. The Manual Ch. Set screen appears.

4 INPUT CHANNEL

The number "01" appears blinking beneath "CH". Press the **NUMBER** keys to input the channel number you want to store.

* If the picture for the entered channel number does not appear, see the left column.

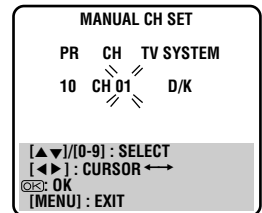

- To select appropriate TV system, press **PUSH JOG** ▷ until TV system setting (B/G or D/K) blinks, then press **PUSH JOG** △▽. Refer to the table on the left also.
- For fine tuning adjustment, press **PUSH JOG** ▷ until the item beneath "CH" begins blinking, then press **PUSH JOG** △▽. While tuning, "F+" or "F-" appears.
- If necessary, to change the band between CH(regular) and CC(cable), press **PUSH JOG** ◁▷ until CH or CC is blinking, then press **PUSH JOG** △▽ to select the band.

5 ENTER NEW CHANNEL INFORMATION

Press **OK** and the Confirmation screen appears.

- Repeat steps 3 through 5 as necessary.

6 CLOSE CONFIRMATION SCREEN

Press **MENU**.

- To input the station name, see page 42.
- To change positions, see "Change Station Channel Position" ☞ pg. 41.

Delete A Channel

Perform steps 1 and 2 of "Storing Channels Manually" on page 40 to access the Confirmation screen before continuing.

- 1** **SELECT ITEM**
Press **PUSH JOG** $\Delta \nabla \triangleleft \triangleright$ until the item you want to delete begins blinking.
- 2** **DELETE CHANNEL**
Press **CANCEL**.
 - The item directly beneath the cancelled one moves up one line.
 - Repeat steps 1 and 2 as necessary.
- 3** **CLOSE CONFIRMATION SCREEN**
Press **MENU**.

Change Station Channel Position

Perform steps 1 and 2 of "Storing Channels Manually" on page 40 to access the Confirmation screen before continuing.

- 1** **SELECT ITEM**
Press **PUSH JOG** $\Delta \nabla \triangleleft \triangleright$ until the item you want to move begins blinking. Then press **OK** and the station name (ID) and its channel (CH) number begin blinking.
- 2** **SELECT NEW POSITION**
Press **PUSH JOG** $\Delta \nabla \triangleleft \triangleright$ to move the station to the new channel position, then press **OK**.
Example: If you moved the station in position 3 to position 7, the stations originally in positions 4–7 each move up one space.
 - Repeat steps 1 and 2 as necessary.
- 3** **CLOSE CONFIRMATION SCREEN**
Press **MENU**.

TV System Selection - When you see the picture but hear no audio

Perform steps 1 and 2 of "Storing Channels Manually" on page 40 to access the Confirmation screen before continuing.

- 1** **SELECT CHANNEL POSITION**
Press **PUSH JOG** $\Delta \nabla \triangleleft \triangleright$ until the channel position you want to change its TV system begins blinking.
- 2** **ACCESS MANUAL CH. SET SCREEN**
Press **OK** three times.
- 3** **SELECT TV SYSTEM**
Press **PUSH JOG** \triangleright until TV system setting (D/K or B/G) begins blinking and then press **PUSH JOG** $\Delta \nabla$ to select the appropriate TV system. Refer to the table on page 40 also.
- 4** **RETURN TO CONFIRMATION SCREEN**
Press **OK**.
 - The Confirmation screen appears.
 - Repeat steps 1 through 4 as necessary.
- 5** **CLOSE CONFIRMATION SCREEN**
Press **MENU**.

Set Stations (A)

Perform steps 1 and 2 of "Storing Channels Manually" on page 40 to access the Confirmation screen before continuing.

- 1** **SELECT ITEM**
Press **PUSH JOG**△▽◀▷ until the item you want begins blinking. Then press **OK** twice and the station's name or "-" begins blinking.
- 2** **SELECT NEW STATION**
Press **PUSH JOG**△▽ until the new station's name (ID) you want to store begins blinking. Registered station names (pg. 43) appear as you press **PUSH JOG**△▽.
- 3** **SWITCH STATIONS**
Press **OK**.
 - Repeat steps 1 through 3 as necessary.
- 4** **CLOSE CONFIRMATION SCREEN**
Press **MENU**.

Set Stations (B)

Perform steps 1 and 2 of "Storing Channels Manually" on page 40 to access the Confirmation screen and then perform step 1 of "Set Stations (A)" above before continuing.

- 2** **SELECT STATION NAME CHARACTER**
Press **PUSH JOG**▷ and the first letter of the station name begins blinking.
- 3** **ENTER NEW CHARACTER**
Press **PUSH JOG**△▽ to cycle through the characters (A-Z, 0-9, -, *, +, — (space)) and stop when the desired one is indicated, then press **PUSH JOG**▷ to enter. Enter the remaining characters the same way (maximum of 4). After entering all characters, press **OK**.
 - Repeat steps 1 through 3 as necessary.
 - If you make a mistake, press **PUSH JOG**◀ until the incorrect character begins blinking. Then enter the correct character by pressing **PUSH JOG**△▽.
- 4** **CLOSE CONFIRMATION SCREEN**
Press **MENU**.

Fine-Tuning Channels Already Stored

Perform steps 1 and 2 of "Storing Channels Manually" on page 40 to access the Confirmation screen before continuing.

- 1** **SELECT CHANNEL TO FINE-TUNE**
Press **PUSH JOG**△▽◀▷ until the channel you want to tune begins blinking.
- 2** **ACCESS MANUAL CH. SET SCREEN**
Press **OK** three times. The Manual Ch. Set screen appears.
- 3** **PERFORM TUNING**
Press **PUSH JOG**△▽ until the picture is its clearest. Then press **OK**.
 - The Confirmation screen appears.
 - Repeat steps 1 through 3 as necessary.
- 4** **CLOSE CONFIRMATION SCREEN**
Press **MENU**.

TV Station And ID List

ID*	STATION NAME
1000	TV1000
3SAT	3SAT
ADLT	ADULT
ANT3	ANTENA3
ARD	ARD
ARTE	ARTE
BBC	BBC GROUP
BBC1	BBC1
BBC2	BBC2
BR3	BAYERN3
C+	CANAL PLUS
C1	PORTUGUSES
CAN5	CANALE5
CH4	CHANNEL4
CH5	CHANNEL5
CHLD	CHILD
CINE	CINEMA
CLUB	TELECLUB
CMT	CMT
CNN	CNN
CSUR	ANDALUCIA
DISC	DISCOVERY
DR	DR TV
DRS	DRS
DSF	DSF
ETB1	ETB1
ETB2	ETB2
EURO	EURONEWS
EUSP	EUROSPORTS
FEMM	FEMMAN
FILM	FILM
FNET	FILMNET
FR2	France2
FR3	France3
GALA	GALAVISION
HR3	HESSEN3
INFO	INFO-KANAL
ITA1	ITALIA1
ITA7	ITALIA7
ITV	ITV
JSTV	JSTV
KA2	KA2
KAB1	KABEL1
KAN2	KANAL2
LOCA	LOCAL
M6	M6
MBC	MBR
MCM	MCM
MDR	MDR
MOVE	MOVIE
MTV	MTV
MTV3	MTV3
N3	NORD3
N-TV	N-TV
NBC	NBC SUPER
NDR3	NDR3
NED1	NED1
NED2	NED2
NED3	NED3
NEWS	
NICK	NICKELODEON
NRK	NRK
NRK2	NRK2
ODE	ODEON
ORF1	ORF1

ID*	STATION NAME
ORF2	ORF2
ORF3	ORF3
OWL3	OWL3
PREM	PREMIERE
PRO7	PRO7
RAI1	RAI1
RAI2	RAI2
RAI3	RAI3
RET4	RETE4
21	TELE21
RTBF	RTBF1 or 2
RTL	RTL
RTL2	RTL2
RTL4	RTL4
RTL5	RTL5
RTP	RTP
S4	SCHWEIZ4
SAT1	SAT1
SBS	SBS
SHOW	SHOW
SIC	SOCIEDADE
SKY	SKY CHANNEL
SKYN	SKY NEWS
SPRT	SPORT
SRTL	SUPER RTL
STAR	STAR-TV
SVT1	SVT1
SVT2	SVT2
SW3	SUEDWEST3
TCC	TCC
TELE	TELE
TEL5	TELE5
TF1	TF1
TM3	TM3
TMC	TELEMONTECARLO
TNT	TNT INT
TRT	TRT INT
TSI	TSI
TSR	TSR
TV1	BRTN TV1
TV2	BRTN TV2
TV3	TV3
TV4	TV4
TV5	TV5
TV6	TV6
TVE1	TVE1
TVE2	TVE2
TVG	TV GALICIA
TVI	TV INDEPENDENT
TVN	TV NORGE
VCR	VIDEO
VERO	VERONICA
VH-1	VH-1
VIVA	VIVA
VIV2	VIVA2
VMTV	VIDEO MUSIC
VOX	VOX
VT4	VT4
VTM	VTM
WDR1	West1
WDR3	West3
YLE1	YLE1
YLE2	YLE2
ZDF	ZDF
ZTV	ZTV

* The "ID" abbreviation is what is shown on-screen in lieu of the station name. The "ID" abbreviation is listed in the Confirmation screen and is displayed on the TV screen when the recorder is tuned to a different station.

Before requesting service for a problem, use this chart and see if you can repair the trouble yourself. Small problems are often easily corrected, and this can save you the trouble of sending your video recorder off for repair.

POWER

SYMPTOM	POSSIBLE CAUSE	CORRECTIVE ACTION
1. No power is applied to the recorder.	<ul style="list-style-type: none"> • The mains power cord is disconnected. 	Connect the mains power cord.
2. The clock is functioning properly, but the recorder cannot be powered.	<ul style="list-style-type: none"> • "⊖" is displayed on the display panel with Auto Timer set to "OFF". 	Press the TIMER button to turn the "⊖" indicator off.
3. The remote control won't function.	<ul style="list-style-type: none"> • The batteries are discharged. • The remote control is set to the wrong code. • The remote control is set to the wrong operating mode. 	Replace the dead batteries with new ones. Re-perform the A/B Code setting (☞ pg. 15). Set the TV/SAT/VCR switch to correct position.

TAPE TRANSPORT

SYMPTOM	POSSIBLE CAUSE	CORRECTIVE ACTION
1. The tape does not run during recording.	<ul style="list-style-type: none"> • "□□" is displayed on the display panel. 	Press PLAY to turn the "□□" indicator off.
2. The tape stops during rewind or fast-forward.	<ul style="list-style-type: none"> • "M" is displayed on the display panel. 	Press C.MEMORY to deactivate the Counter Memory function and turn the "M" indicator off.
3. The tape will not rewind or fast-forward.	<ul style="list-style-type: none"> • The tape is already fully rewound or fast-forwarded. 	Check the cassette.

PLAYBACK

SYMPTOM	POSSIBLE CAUSE	CORRECTIVE ACTION
1. The playback picture does not appear while the tape is running.	<ul style="list-style-type: none"> • If you're using the RF OUT connection the TV receiver's channel selector is not set to the VIDEO channel. . . . the recorder's VIDEO channel has not been correctly set. • If you're using the AV connection, the TV receiver is not set to the AV mode. 	If you are using the RF OUT connection set the TV receiver to the VIDEO channel. (☞ pg. 6) . . . Perform "Video Channel Set" (☞ pg. 6) If you are using the AV connection, set the TV to its AV mode.
2. Noise appears during normal playback.	<ul style="list-style-type: none"> • The automatic tracking mode is engaged. 	Try manual tracking. (☞ pg. 12)
3. Noise appears during slow-motion playback.	<ul style="list-style-type: none"> • The automatic tracking mode is engaged. 	Try manual tracking. (☞ pg. 12)
4. Noise appears during still playback.		Press TV PROG + or - a few times to remove the noise bars from the screen.
5. Breaks are noticeable in Hi-Fi soundtrack.	<ul style="list-style-type: none"> • Automatic tracking is engaged. 	Engage and adjust tracking manually. (☞ pg. 12)
6. The playback picture is blurred or interrupted while TV broadcasts are clear.	<ul style="list-style-type: none"> • The video heads may be dirty. 	Consult your JVC dealer.
7. No sound accompanies the playback picture with RF connection.	<ul style="list-style-type: none"> • The TV system you have selected is incorrect. 	Set it to the correct position for the TV broadcast system used in your area. (☞ pg. 6.)

RECORDING

SYMPTOM	POSSIBLE CAUSE	CORRECTIVE ACTION
1. Recording cannot be started.	<ul style="list-style-type: none"> There is no cassette loaded, or the cassette loaded has had its Record Safety tab removed. 	Insert a cassette, or using adhesive tape, reseal the slot where the tab was removed.
2. TV broadcasts cannot be recorded.	<ul style="list-style-type: none"> "AU" has been selected as the input mode. 	Set to the desired channel.
3. Tape-to-tape editing is not possible.	<ul style="list-style-type: none"> The source (another video recorder, camcorder) has not been properly connected. All necessary power switches have not been turned on. The input mode is not correct. 	<p>Confirm that the source is properly connected.</p> <p>Confirm that all units' power switches are turned on. Set the input mode to "AU".</p>
4. Camcorder recording is not possible.	<ul style="list-style-type: none"> The camcorder has not been properly connected. The input mode is not correct. 	<p>Confirm that the camcorder is properly connected.</p> <p>Set the input mode to "AU".</p>

TIMER RECORDING

SYMPTOM	POSSIBLE CAUSE	CORRECTIVE ACTION
1. Timer recording won't work.	<ul style="list-style-type: none"> The clock and/or the timer have been set incorrectly. The timer is not engaged. 	Re-perform the clock and/or timer settings. Press TIMER and confirm that "Ⓢ" is displayed on the display panel.
2. On-screen timer programming is not possible.	<ul style="list-style-type: none"> Timer recording is in progress. 	Timer programming can't be performed while a timer recording is in progress. Wait until it finishes.
3. "Ⓢ" and "Ⓢ" on the display panel won't stop blinking.	<ul style="list-style-type: none"> The timer is engaged but there's no cassette loaded. 	Load a cassette with the Record Safety tab intact, or cover the hole using adhesive tape.
4. The cassette is automatically ejected, and "Ⓢ" and "Ⓢ" on the display panel won't stop blinking.	<ul style="list-style-type: none"> The loaded cassette has had its Record Safety tab removed. 	Remove the cassette and cover the hole with adhesive tape, or insert a cassette with the Record Safety tab intact.
5. "Ⓢ" blinks for 10 seconds and the Timer mode is disengaged.	<ul style="list-style-type: none"> TIMER has been pressed when there are no programs in memory, or the timer record information has been programmed incorrectly. 	Check the programmed data and re-program as necessary, then press TIMER again.
6. The cassette is automatically ejected, the power shuts off and "Ⓢ" and "Ⓢ" won't stop blinking.	<ul style="list-style-type: none"> The end of the tape was reached during timer recording. 	The programme may not have been recorded in its entirety. Next time make sure you have enough time on the tape to record the entire programme.
7. SHOWVIEW does not timer-record properly.	<ul style="list-style-type: none"> The recorder's channel positions have been set incorrectly. 	Refer to "SHOWVIEW Setup" and re-perform the procedure (ⓘ pg. 22).

OTHER PROBLEMS

SYMPTOM	POSSIBLE CAUSE	CORRECTIVE ACTION
1. Whistling or howling is heard from the TV during camcorder recording.	<ul style="list-style-type: none"> ● The camcorder's microphone is too close to the TV. ● The TV's volume is too high. 	Position the camcorder so its microphone is away from the TV. Turn the TV's volume down.
2. When scanning channels, some of them are skipped over.	<ul style="list-style-type: none"> ● Those channels have been designated to be skipped. 	If you need the skipped channels, restore them (☞ pg. 40).
3. The channel cannot be changed.	<ul style="list-style-type: none"> ● Recording is in progress. 	Press PAUSE to pause the recording, change channels, then press PLAY to resume recording.
4. Channel settings that were made manually seem to have changed or disappeared.	<ul style="list-style-type: none"> ● After the manual settings were made, Auto Channel Set was performed. 	Perform manual setting again.
5. No channels are stored in the recorder's memory.	<ul style="list-style-type: none"> ● The TV aerial cable was not connected to the recorder when Auto Set Up was performed. 	Connect the TV aerial cable to the recorder properly and turn off the recorder power once, then turn the recorder power back on again. The recorder will try Auto Set Up again (☞ pg. 4).

PLAYBACK

Q. What happens if the end of the tape is reached during playback or search?

A. The tape is automatically rewound to the beginning.
.....

Q. Can the video recorder indefinitely remain in the still mode?

A. No. It stops automatically after 5 minutes to protect the heads.
.....

Q. When returning from multi-speed search to normal playback, the picture is disturbed. Should I be concerned about this?

A. No, it is normal.
.....

Q. Other than preventing further recording, what effect does removing the Record Safety tab have?

A. It disables marking of index codes.
.....

Q. Sometimes, during Index Search, the video recorder can't find the programme I want to see. Why not?

A. There may be index codes too close together.
.....

RECORDING

Q. When I pause and then resume a recording, the end of the recording before the pause is overlapped by the beginning of the continuation of recording. Why does this happen?

A. This is normal. It reduces distortion at the pause and resume points.
.....

Q. Can the video recorder indefinitely remain in the Record-Pause mode?

A. No. The video recorder goes to its Stop mode automatically after 5 minutes to protect the heads.
.....

Q. What happens if the tape runs out during recording?

A. The video recorder automatically rewinds it to the beginning.
.....

TIMER RECORDING

Q. "O" and "⊖" remain lit on the display panel. Is there a problem?

A. No. This is a normal condition for a timer recording in progress.
.....

Q. Can I program the timer while I'm watching a tape or a TV broadcast?

A. You won't see the picture as it is replaced by the on-screen menu, but the audio from the program or tape you're viewing can be heard.
.....

ATTENTION:

This recorder contains microcomputers. External electronic noise or interference could cause malfunctioning. In such cases, switch the recorder off and unplug the mains power cord. Then plug it in again and turn the recorder on. Take out the cassette. After checking the cassette, operate the unit as usual.

FRONT VIEW

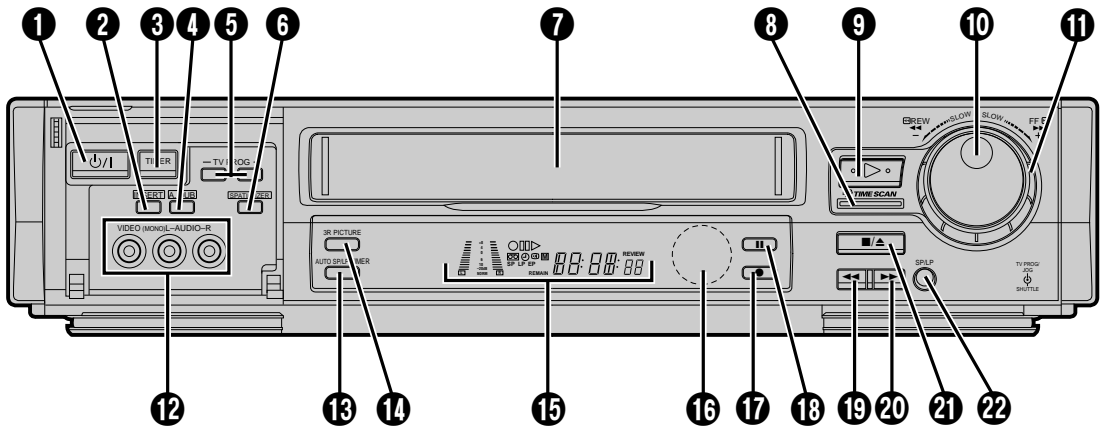

Open the lid to access covered connectors and buttons.

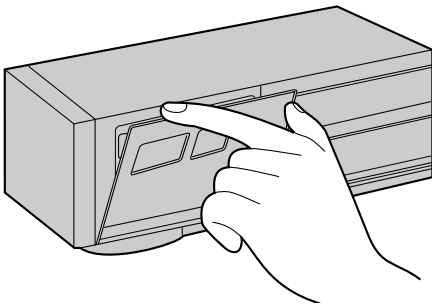

- ❶ STANDBY/ON ψ/I Button \hookrightarrow pg. 4
- ❷ INSERT Button \hookrightarrow pg. 37
- ❸ TIMER Button \hookrightarrow pg. 25, 27
- ❹ A. DUB [Audio Dubbing] Button \hookrightarrow pg. 35
- ❺ TV PROG +/- Buttons \hookrightarrow pg. 18
- ❻ SPATIALIZER Button \hookrightarrow pg. 14
- ❼ Cassette Loading Slot
- ❽ TIME SCAN Indicator \hookrightarrow pg. 16
- ❾ PLAY Button \hookrightarrow pg. 10
- ❿ TV PROG Dial \hookrightarrow pg. 18
JOG Dial \hookrightarrow pg. 11
- ⓫ TIME SCAN SHUTTLE Ring \hookrightarrow pg. 16

- ⓬ VIDEO/AUDIO Input Connectors \hookrightarrow pg. 34
- ⓭ AUTO SP/LP TIMER Button \hookrightarrow pg. 29
- ⓮ 3R PICTURE Button \hookrightarrow pg. 12
- ⓯ Display Panel \hookrightarrow pg. 49
- ⓰ Infrared Beam Receiving Window
- ⓱ RECORD Button \hookrightarrow pg. 18
- ⓲ PAUSE Button \hookrightarrow pg. 11
- ⓳ Rewind [REW] Button \hookrightarrow pg. 10
- ⓴ Fast Forward [FF] Button \hookrightarrow pg. 10
- ⓵ STOP/EJECT Button \hookrightarrow pg. 10
- ⓶ SP/LP Button \hookrightarrow pg. 18

REAR VIEW

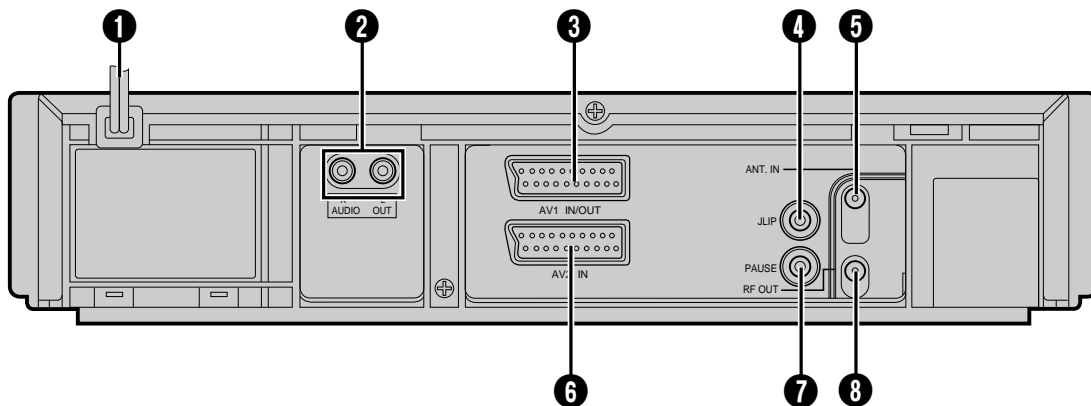

- ❶ Mains Power Cord ☞ pg. 3
- ❷ AUDIO OUT(L/R) Connectors ☞ pg. 3
- ❸ AV1 IN/OUT Connector ☞ pg. 3, 32
- ❹ J Terminal [JLIP(Joint Level Interface Protocol) Connector] ☞ pg. 38
- ❺ ANT. IN Connector ☞ pg. 3
- ❻ AV2 IN Connector ☞ pg. 32
- ❼ Remote PAUSE Connector ☞ pg. 34
- ❽ RF OUT Connector ☞ pg. 3

DISPLAY PANEL

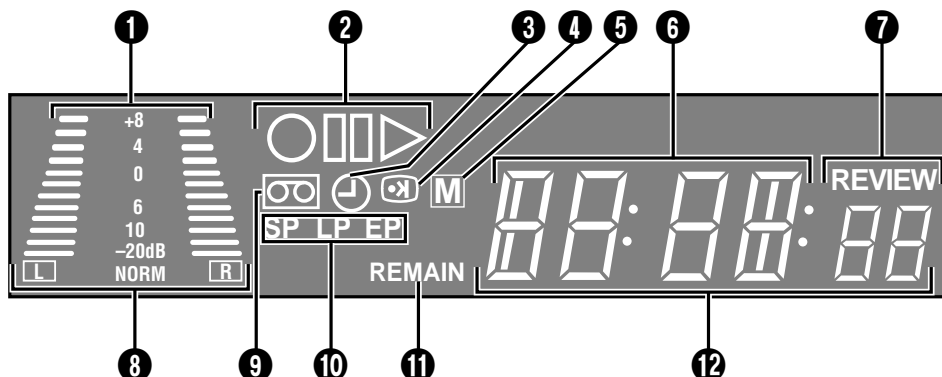

- ❶ B.E.S.T. Picture System Display ☞ pg. 20
Audio Level Indicator
- ❷ Symbolic Mode Indicators
- ❸ "Timer" Indicator ☞ pg. 25, 27
- ❹ VPS Indicator ☞ pg. 29
- ❺ Counter Memory Indicator ☞ pg. 15
- ❻ Channel*/Mode Display ☞ pg. 10
*Channel position 1 will be displayed as "CH 1".
Clock Display ☞ pg. 8
- ❼ Instant REVIEW Indicator ☞ pg. 13
- ❽ Audio Mode Indicator ☞ pg. 14
- ❹ "Cassette Loaded" Mark
- ❺ Tape Speed Indicators ☞ pg. 18
- ❻ Tape Remaining Time Indicator ☞ pg. 19
- ❼ Counter/Remain Display ☞ pg. 19

PLAY: FF/REW VARIABLE SHUTTLE SEARCH:	▶	STILL: SLOW:	▢▶
		RECORD:	○
		RECORD PAUSE:	○▢▶
AUDIO DUBBING:		☼▶	
AUDIO DUBBING PAUSE:		☼▢▶	
INSERT:		○▶	
INSERT PAUSE:		○▢▶	
AUDIO DUBBING INSERT:		☼▶☼▶	
AUDIO DUBBING INSERT PAUSE:		☼▢▶☼▶	

REMOTE CONTROL

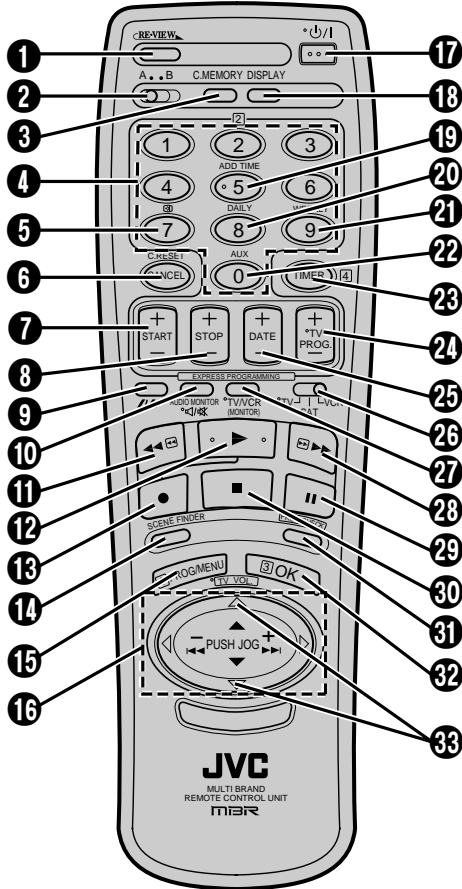

Buttons with a small dot on the left side of the name can also be used to operate your TV with the TV/SAT/VCR switch set to "TV". [pg. 30](#)

- 1 REVIEW Button [pg. 13](#)
- 2 A/B Code Switch [pg. 15](#)
- 3 C. MEMORY Button [pg. 15](#)
- 4 NUMBER Keys [pg. 18, 24](#)
- 5 (VPS) Button [pg. 24, 27](#)
- 6 CANCEL Button [pg. 28](#)
- 7 START +/- Button [pg. 26](#)
- 8 STOP +/- Button [pg. 26](#)
- 9 SP/LP Button [pg. 18](#)
- Auto Tracking Button [pg. 12](#)
- Digit Entry Button [pg. 30](#)
- 10 AUDIO MONITOR Button [pg. 14](#)
- TV Mute Button [pg. 30](#)
- 11 Rewind [REW] Button [pg. 10](#)
- 12 Play Button [pg. 10](#)
- 13 Record Button [pg. 18](#)
- 14 SCENE FINDER Button [pg. 15](#)
- 15 PROG/MENU Button [pg. 5, 24](#)
- 16 PUSH JOG Δ∇◀▶ Button [pg. 5](#)
- PUSH JOG ◀▶ Button [pg. 11, 13, 30](#)
- 17 STANDBY/ON ⏻ Button [pg. 4](#)
- 18 DISPLAY Button [pg. 19](#)
- 19 ADD TIME Button [pg. 25](#)
- 20 DAILY Button [pg. 25, 27](#)
- 21 WEEKLY Button [pg. 25, 27](#)
- 22 AUX Button [pg. 32](#)
- 23 TIMER Button [pg. 25, 27](#)
- 24 TV PROG +/- Button [pg. 18](#)
- 25 DATE +/- Button [pg. 26](#)
- 26 TV/SAT/VCR Switch [pg. 30, 31](#)
- 27 TV/VCR Button [pg. 30](#)
- 28 Fast Forward [FF] Button [pg. 10](#)
- 29 Pause Button [pg. 11](#)
- 30 Stop Button [pg. 10](#)
- 31 PROG CHECK Button [pg. 28](#)
- 32 OK Button [pg. 5](#)
- 33 TV VOL Δ∇ Button [pg. 30](#)

Installing Batteries

- 1 Open the battery compartment cover.
- 2 Insert 2 "R6"-size batteries (provided) in the correct directions.
- 3 Replace the cover.

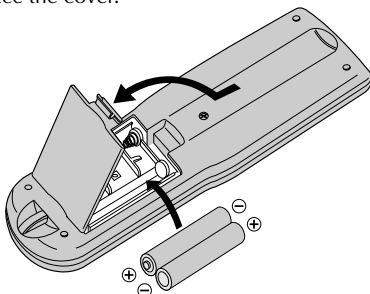

How To Use

- The remote control can operate most of your video recorder's functions, as well as basic functions of TV sets and satellite tuners of JVC and other brands. [pg. 30, 31.](#)
- Point the remote control toward the sensor window.
 - The maximum operating distance of the remote control is about 8 m.

NOTE:

If the remote control doesn't work properly, remove its batteries, wait a short time and then try again.

GENERAL

Power requirement	
Rating	: AC 110 – 240 V~, 50/60 Hz
Operating	: AC 90 – 260 V~, 50/60 Hz
Power consumption	: 24 W
Temperature	
Operating	: 5°C to 40°C
Storage	: -20°C to 60°C
Operating position	: Horizontal only
Dimensions (WxHxD)	: 430 x 94 x 348 mm
Weight	: 4.5 kg
Format	: VHS standard
Maximum recording time	
(SP)	: 240 min. with E-240 video cassette (PAL/MESECAM)
(LP)	: 480 min. with E-240 video cassette (PAL/MESECAM)

VIDEO/AUDIO

Signal system	: PAL-type colour signal and CCIR monochrome signal, 625 lines 50 fields
Recording system	: DA-4 (Double Azimuth) head helical scan system
Signal-to-noise ratio	: 45 dB
Horizontal resolution	: 250 lines (PAL/MESECAM)
Frequency range	: 70 Hz to 10,000 Hz (Normal audio) 20 Hz to 20,000 Hz (Hi-Fi audio)
Input/Output	: 21-pin SCART connectors: IN/OUT x 1, IN x 1 RCA connectors: VIDEO IN x 1, AUDIO IN x 1, AUDIO OUT x 1

TUNER/TIMER

TV channel storage capacity	: 99 positions (+AUX position "AU")
Tuning system	: Frequency synthesized tuner
Channel coverage	: VHF 47 – 100/104 – 300/ 302 – 470MHz UHF 470 – 862MHz
Aerial output	: UHF channels (Adjustable E22 – E69)
Memory backup time	: Approx. 18 hours.
Backup time becomes shorter as the unit's internal parts become old. When this occurs, please consult your nearby JVC dealer.	

ACCESSORIES

Provided accessories	: RF cable, Infrared remote control unit, "R6/UM-3" battery x 2
----------------------	---

Specifications shown are for SP mode unless otherwise specified.

Design and specifications subject to change without notice.

EN

HR-DD949EE

JVC
VICTOR COMPANY OF JAPAN, LIMITED